

Anbauanleitung: Seilwindenanbausatz Isuzu D-Max3 ab Bj.2020

AL: 2287-03

Best.Nr.: 16-8130

Montagezeit: ca. 240 min.

***Hier sehen sie den fertig montierten Seilwindenanbausatz.
Bevor sie mit der Montage beginnen, lesen sie bitte diese Anleitung und das
Benutzerhandbuch der Seilwinde gut durch.***

***Before you start fitting, please read and understand this instruction manual and the owners
manual of the winch.***



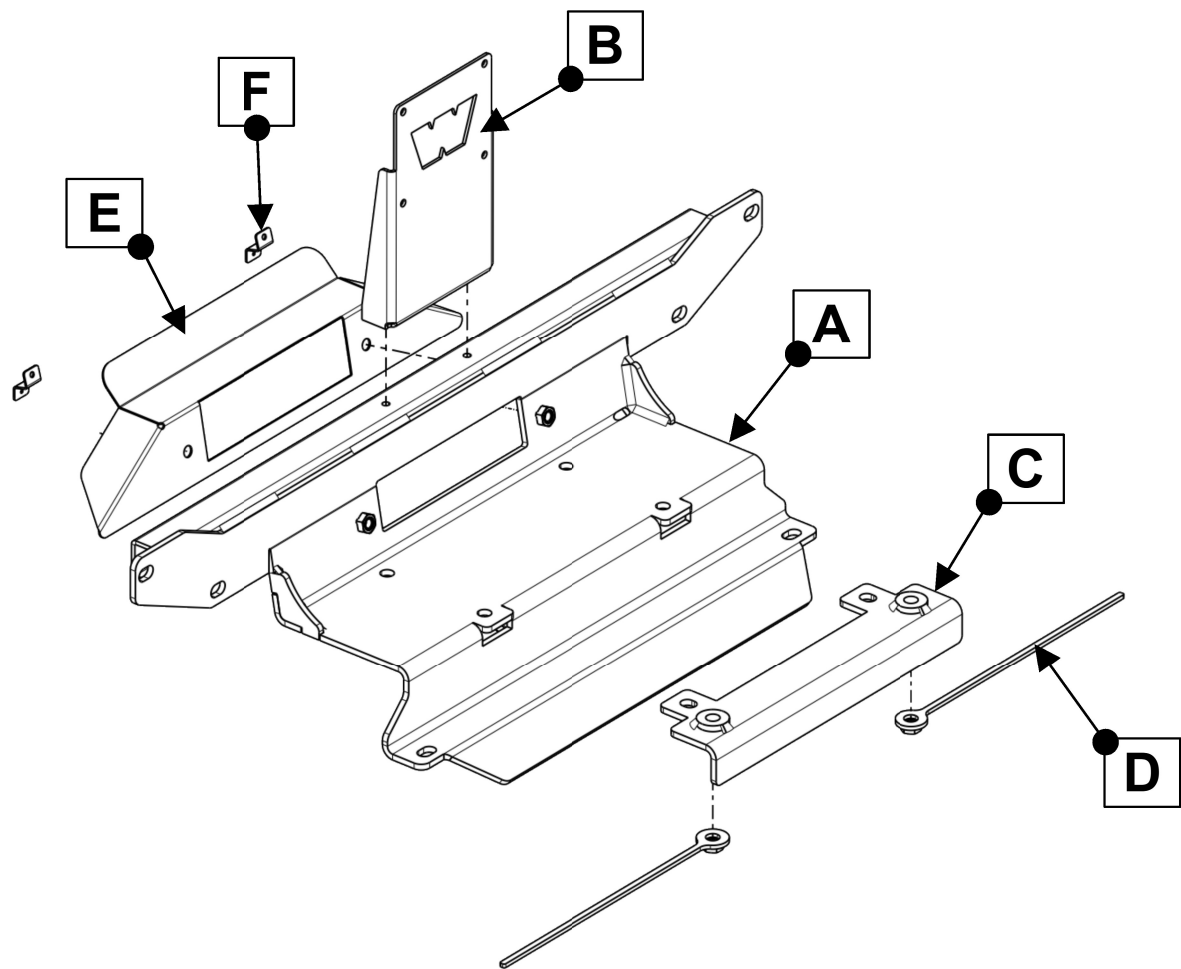

Stückliste

16-813

Schraubensatz

1x Windenplatte (A)
 1x Schaltkastenhalter (B)
 2x Gewindeleiste (C)
 1x Haltewinkel (D)
 1x Blende (E)
 2x Distanzwinkel (F)

1x 16-0520, Nummernschildhalter schiebbar

1x 5-07940150, Kennzeichenunterlage
 „Taubenreuther“

1x 16-2190,
 Sicherungskit für alle Fahrzeugwinden
 ab 3,6t, inkl. 500A Sicherung & Halter

1x Anbauanleitung AL2287
 1x Gutachten
 1x Aufkleber Kennzeichnung
 (Bitte an einer sichtbaren Stelle
 anbringen! TÜV Relevant)

2x Schraube M6 x 55
 4x Scheibe M6
 2x Ferderring M6
 2x Mutter M6

4x Schraube M10 x 35
 2x Zylinderschraube M10 x 40
 6x Schraube M10 x 1,25 x 35
 4x Scheibe M10 x 30 x 3
 6x Scheibe M10 x 25 x 2
 10x Federring M10

7x Schraube M5 x 12
 18x Scheibe M5 x 13 x 1
 4x Zahnscheibe M5
 7x Stopmutter M5

Schrauben Anzugsmomente siehe letzte Seite!
For torque information please see last page!

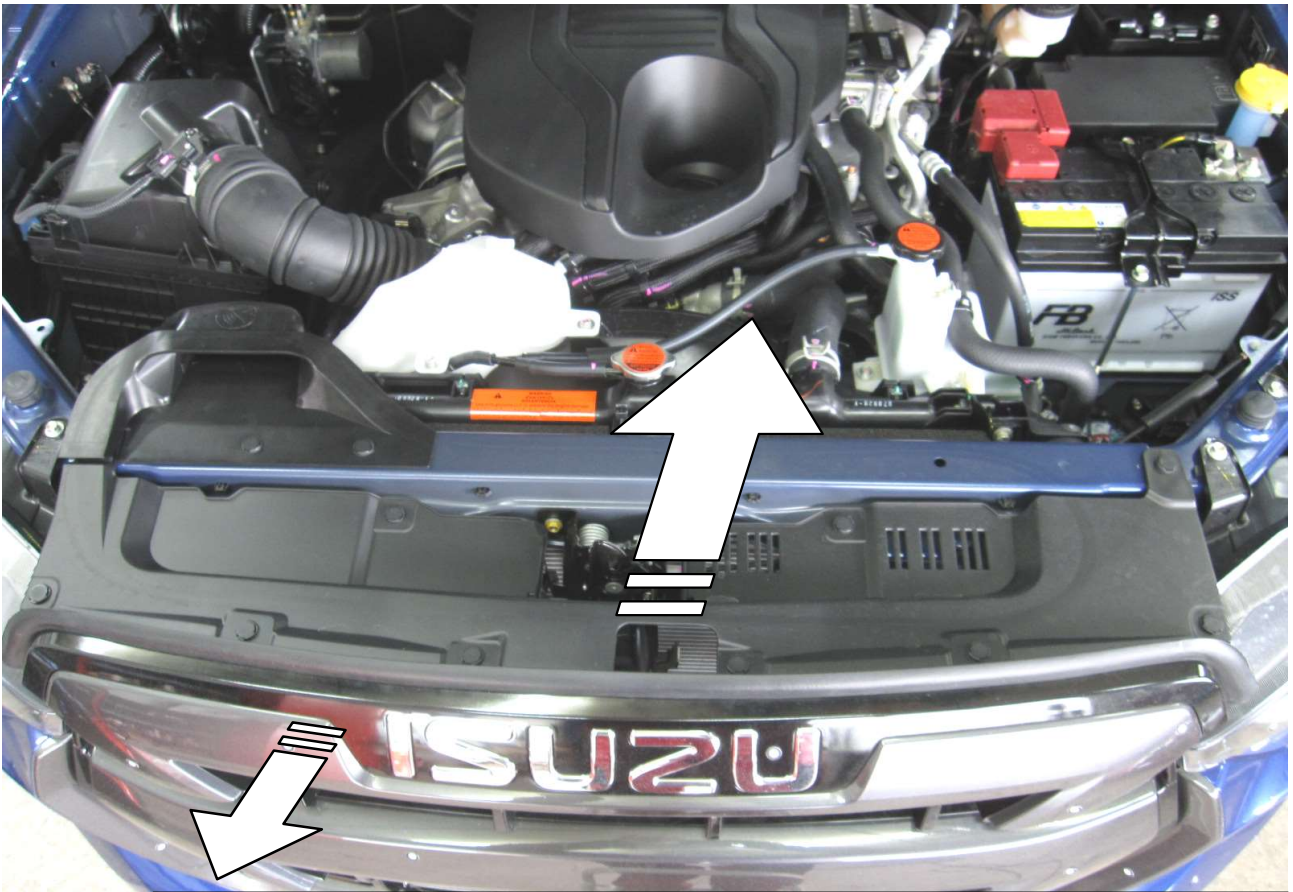

1

Abdeckung und oberen Teil des Kühlergrills entfernen!
Remove the cover and the upper part form the radiator grille!

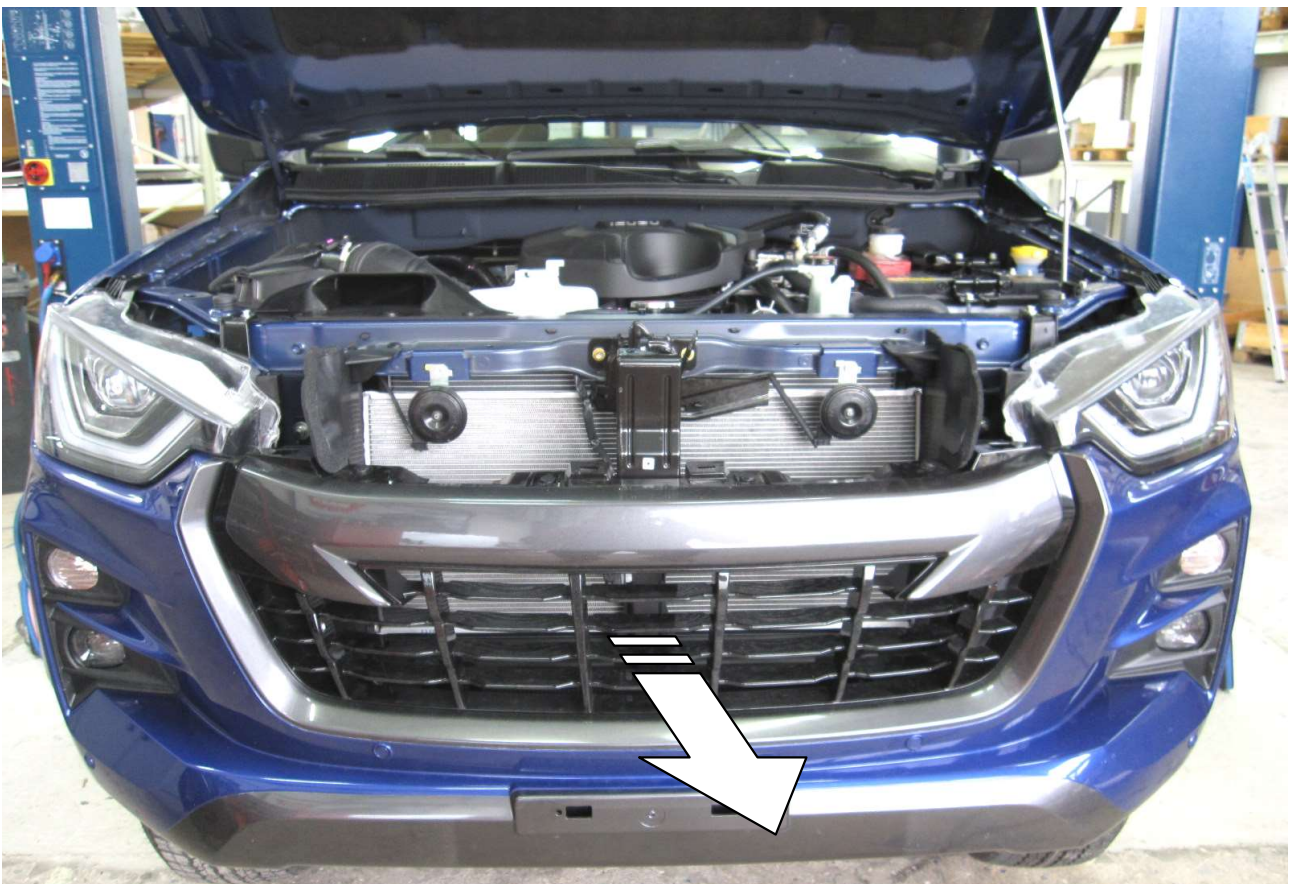

2

Stoßfänger entfernen! / Remove the bumper!

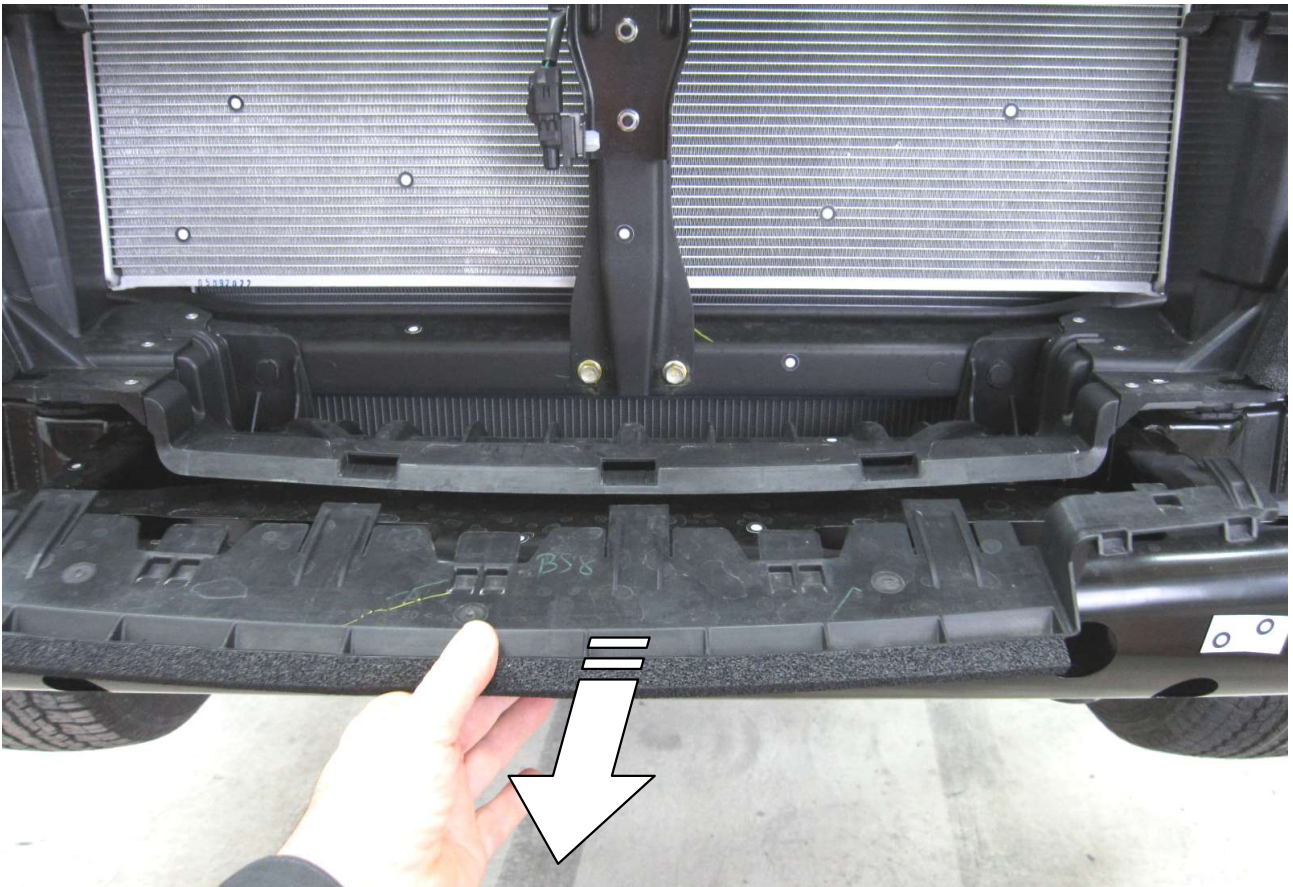

3

Vorderes Teil vom Luftleitkanal abbauen!
Remove the front part of the air duct!

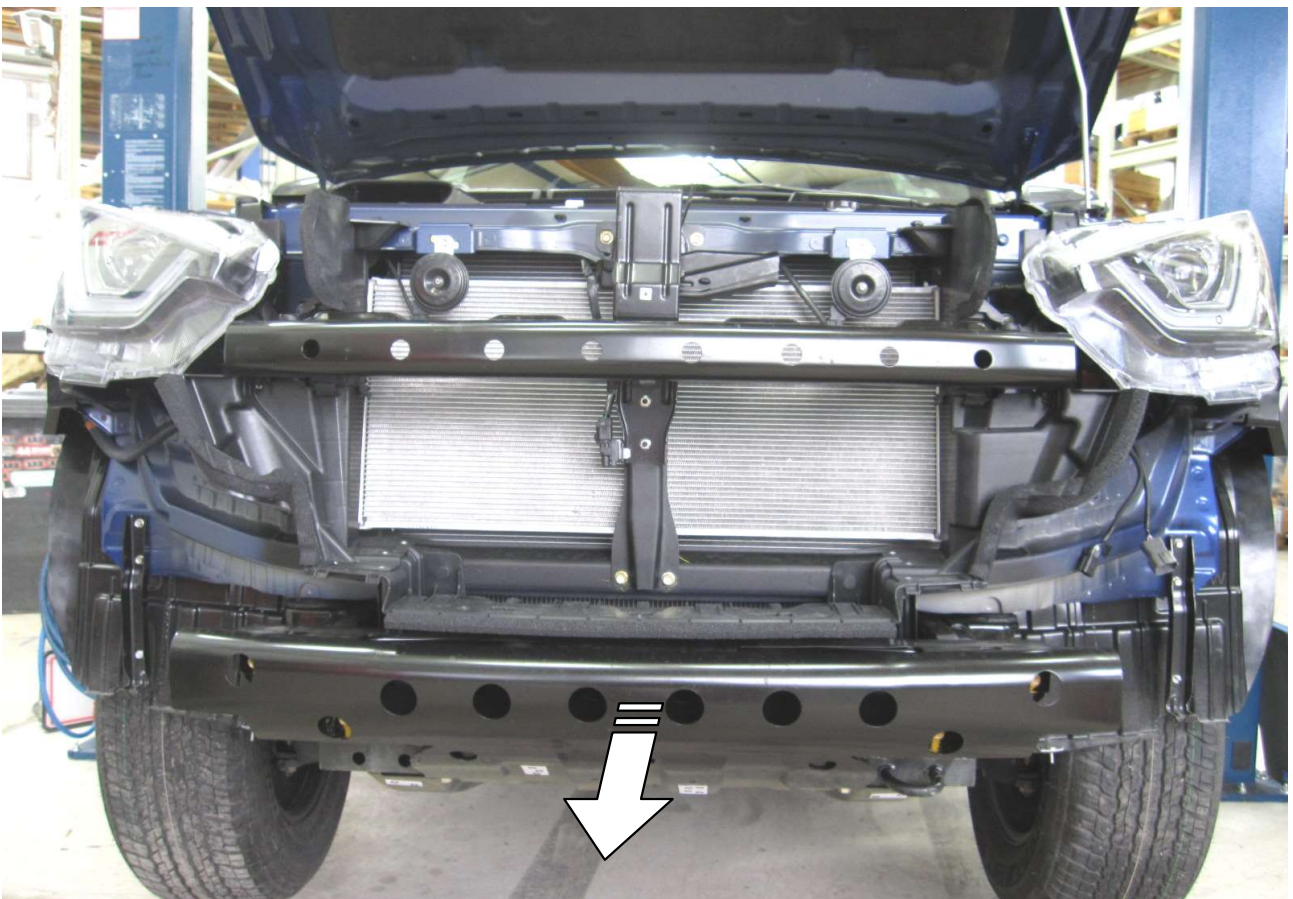

4

Traverse entfernen! / Remove the traverse!



5

Vorderen Teil des Unterfahrschutzes entfernen!
Remove the front part of the skid plate!

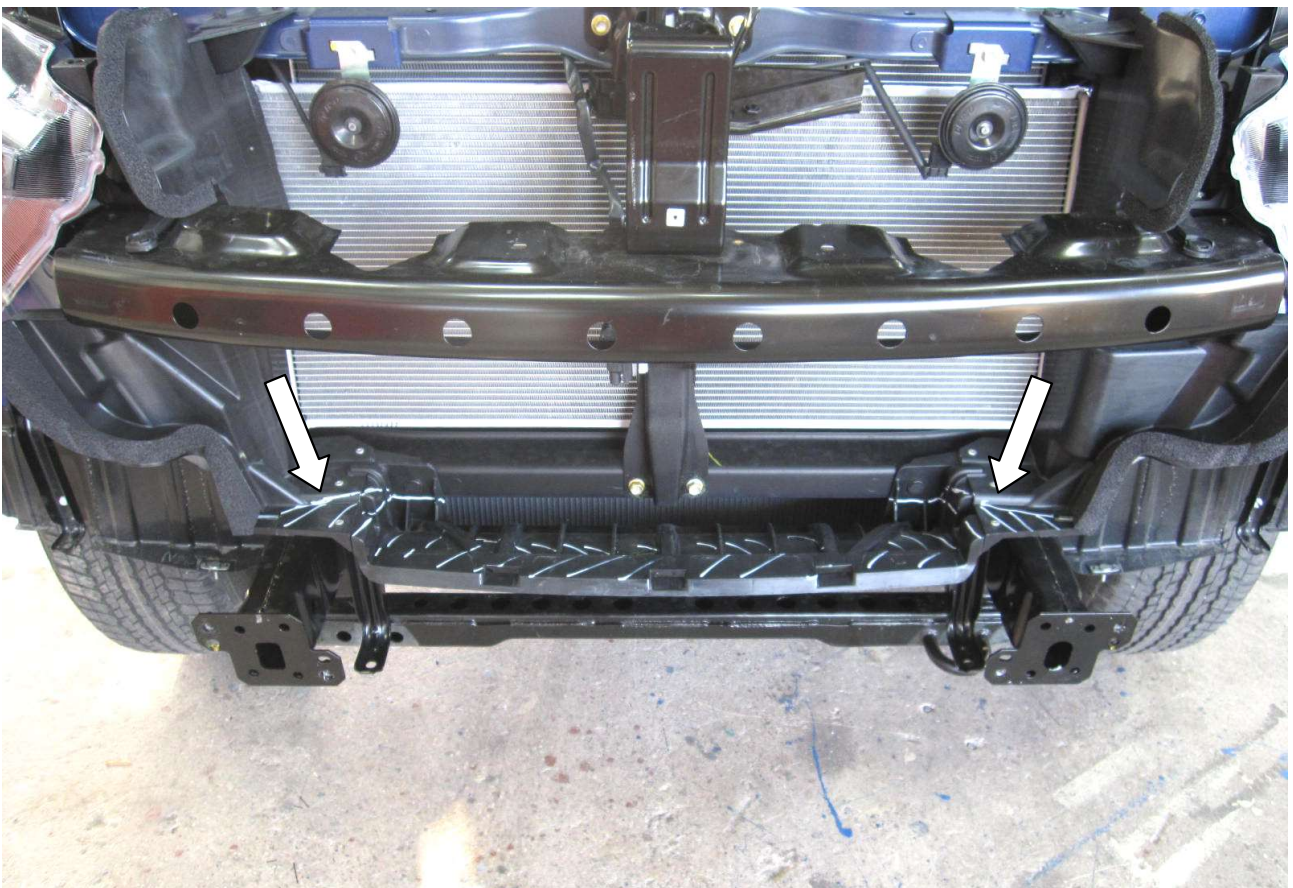

6

Luftkanal wie angezeichnet ausschneiden!
Cut out the air duct, how marked!

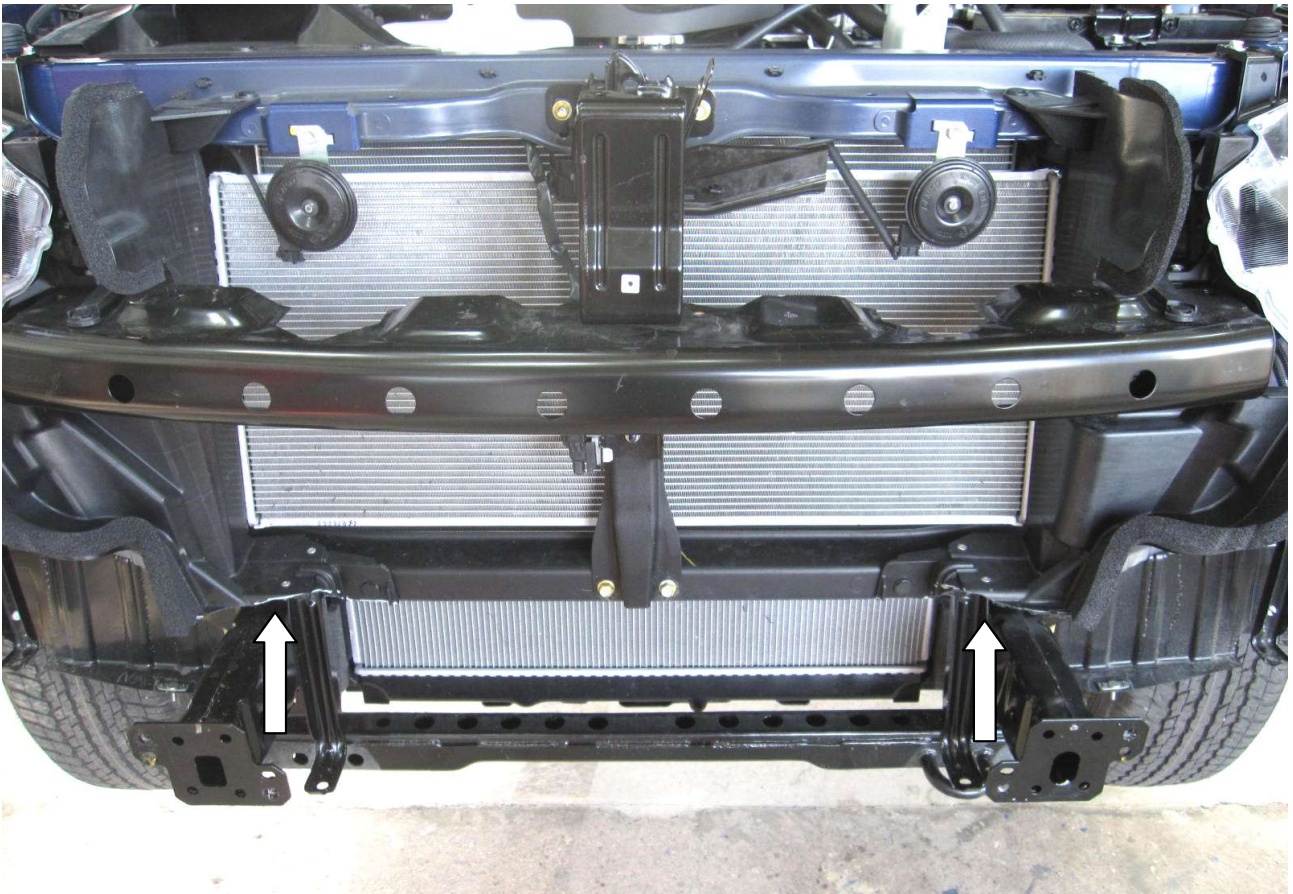

7

Nach dem ausschneiden / Afer cut!

INFO:
Das Seil wurde zur besseren Ansicht entfernt!
The rope has been removed for a better view!



8

Schaltkasten der Seilwinde entfernen! Anleitung der Seilwinde beachten!
Remove the control box of the winch! Observe the instructions for the cable winch!

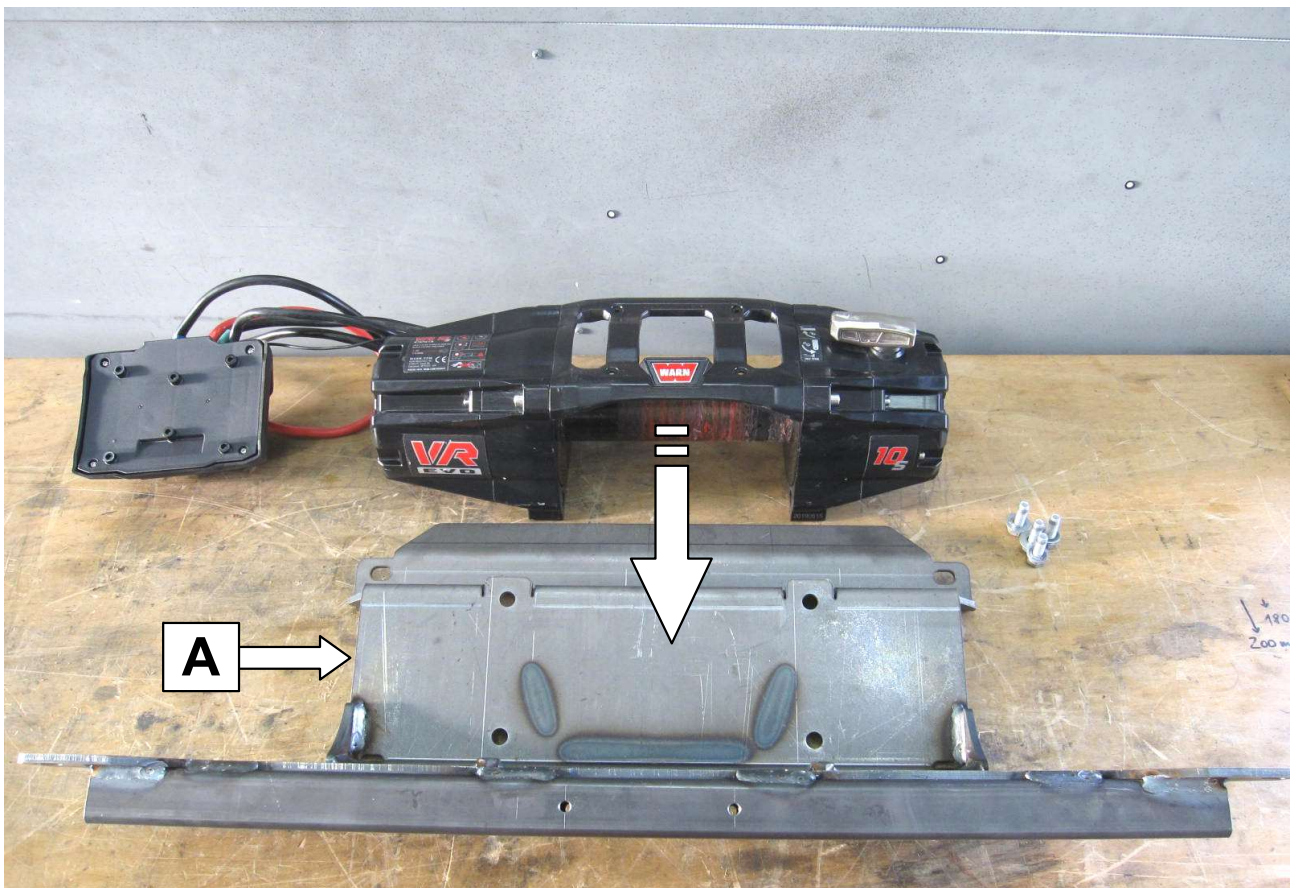

9

Seilwinde auf der Windenplatte platzieren!
Place the winch at the winch plate!

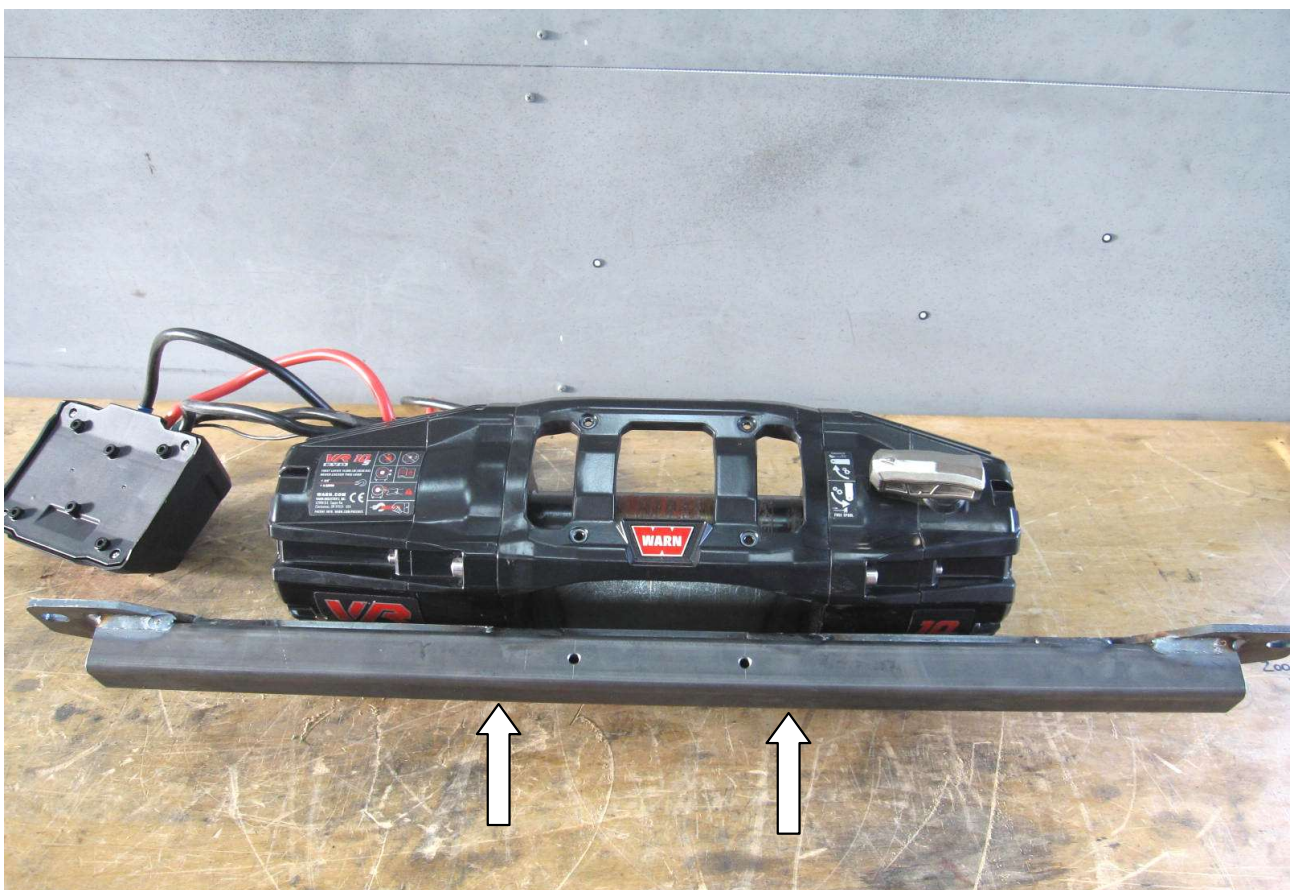

10

Die Seilwinde nur mit den vorderen Schrauben befestigen!
Mount the winch only with the front screws!

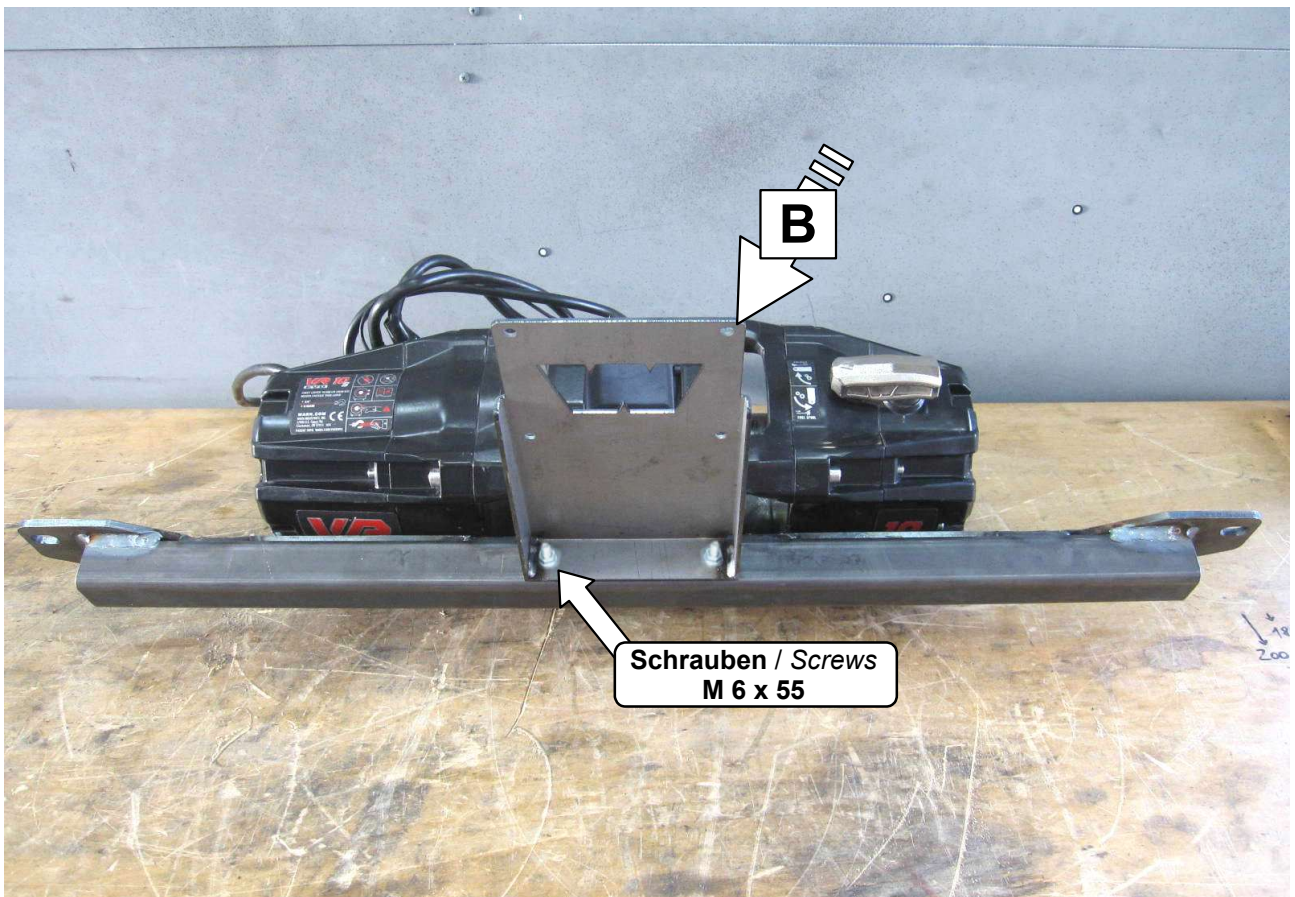

11 Schaltkastenhalter montieren! / *Mount the bracket for switch box!*

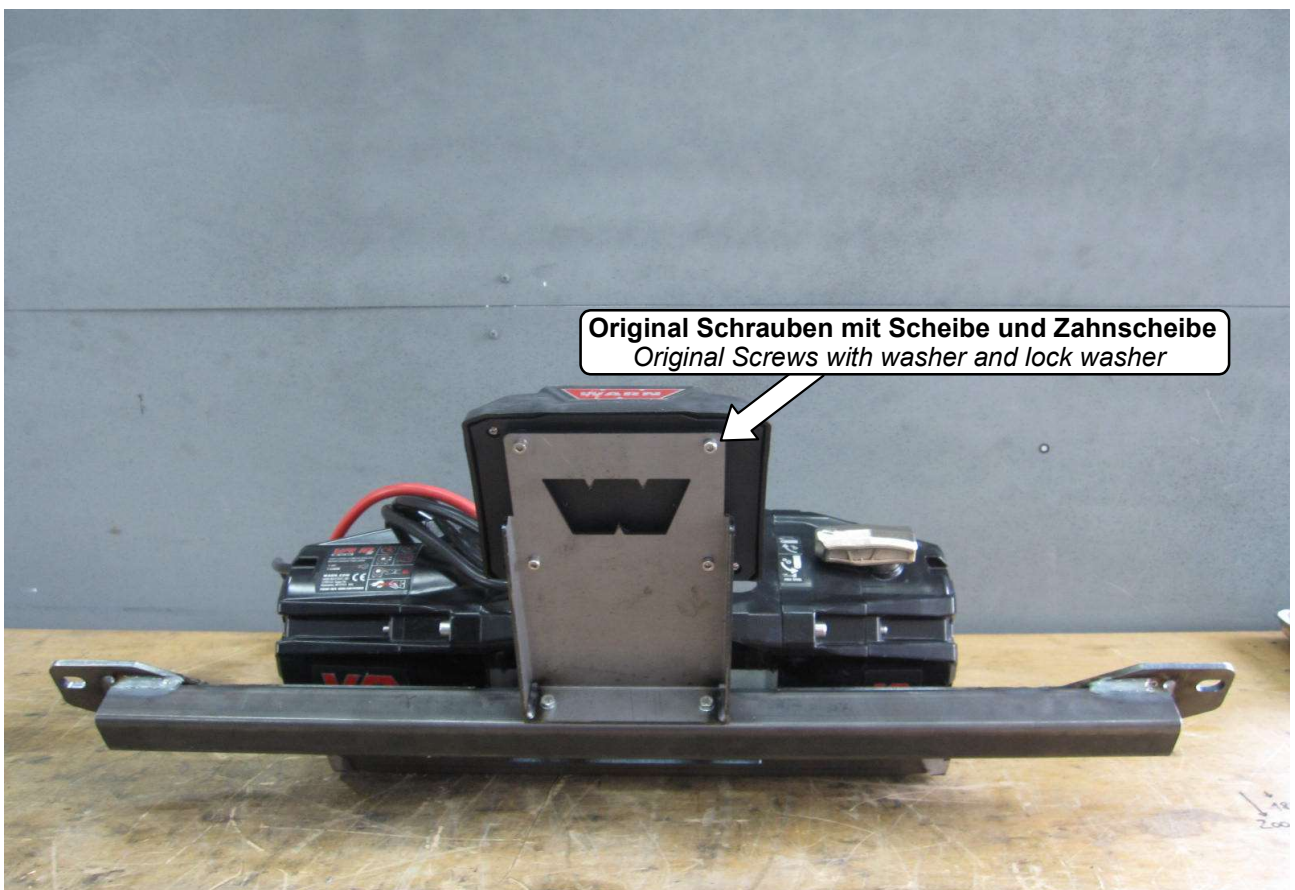

12 Schaltkasten mit original Schrauben montieren! / *Mount the switch box with the original screws!*

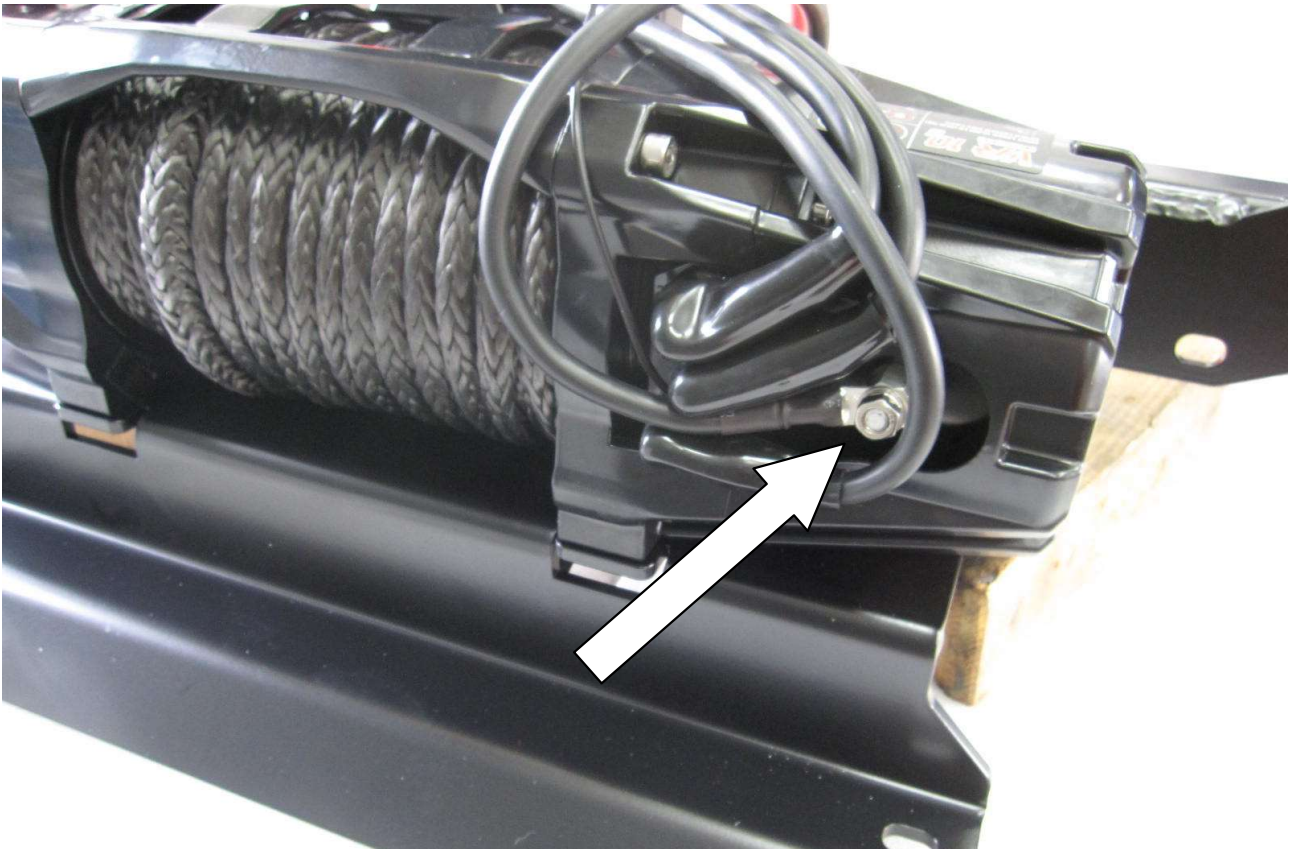

13

Massekabel gemäß der Einbauanleitung der Seilwinde an der Winde montieren!

Mount the ground cable to the winch according to the assembly instructions of the winch!

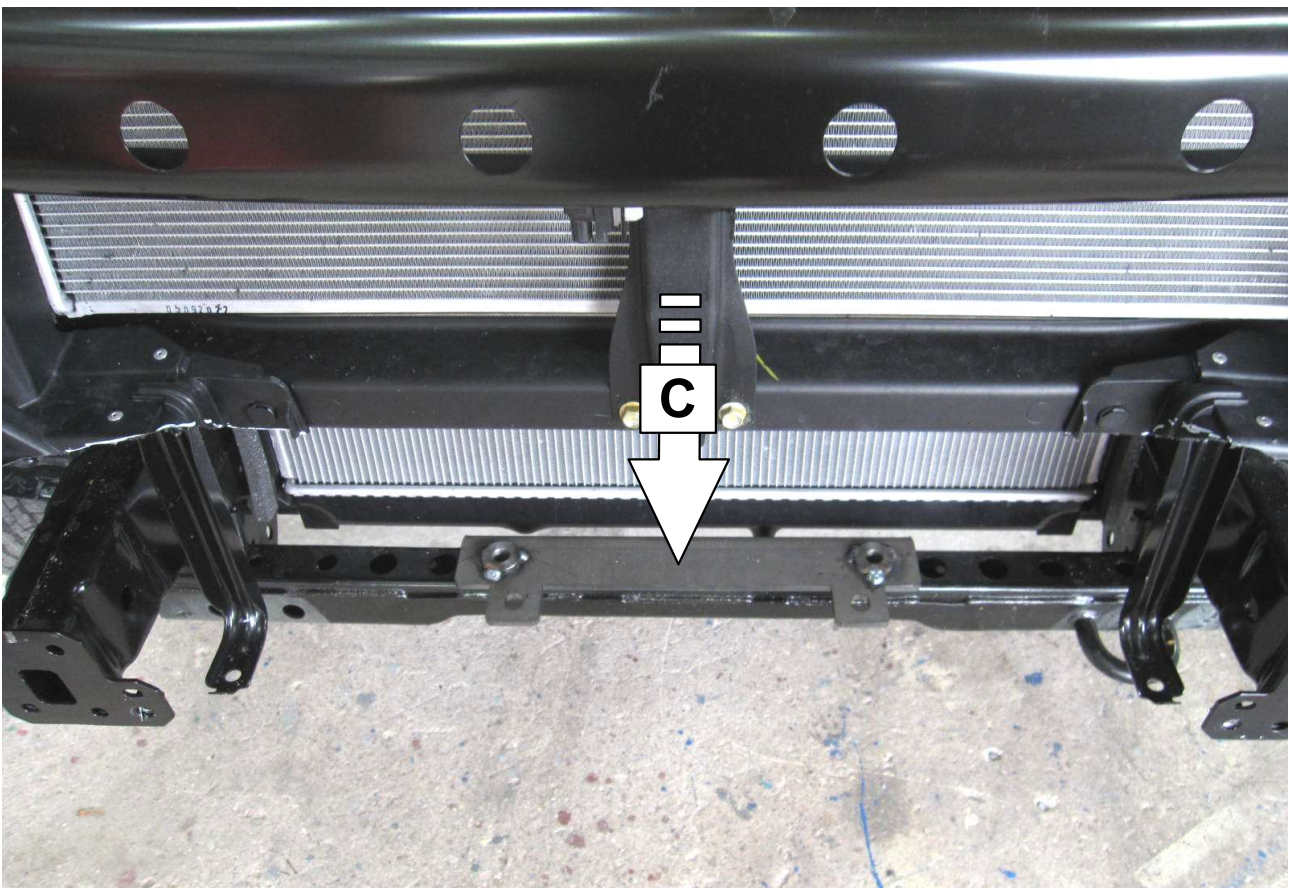

14

Haltewinkel mittig auf der Querstrebe platzieren!

Mount the bracket centrally on the crosshead!

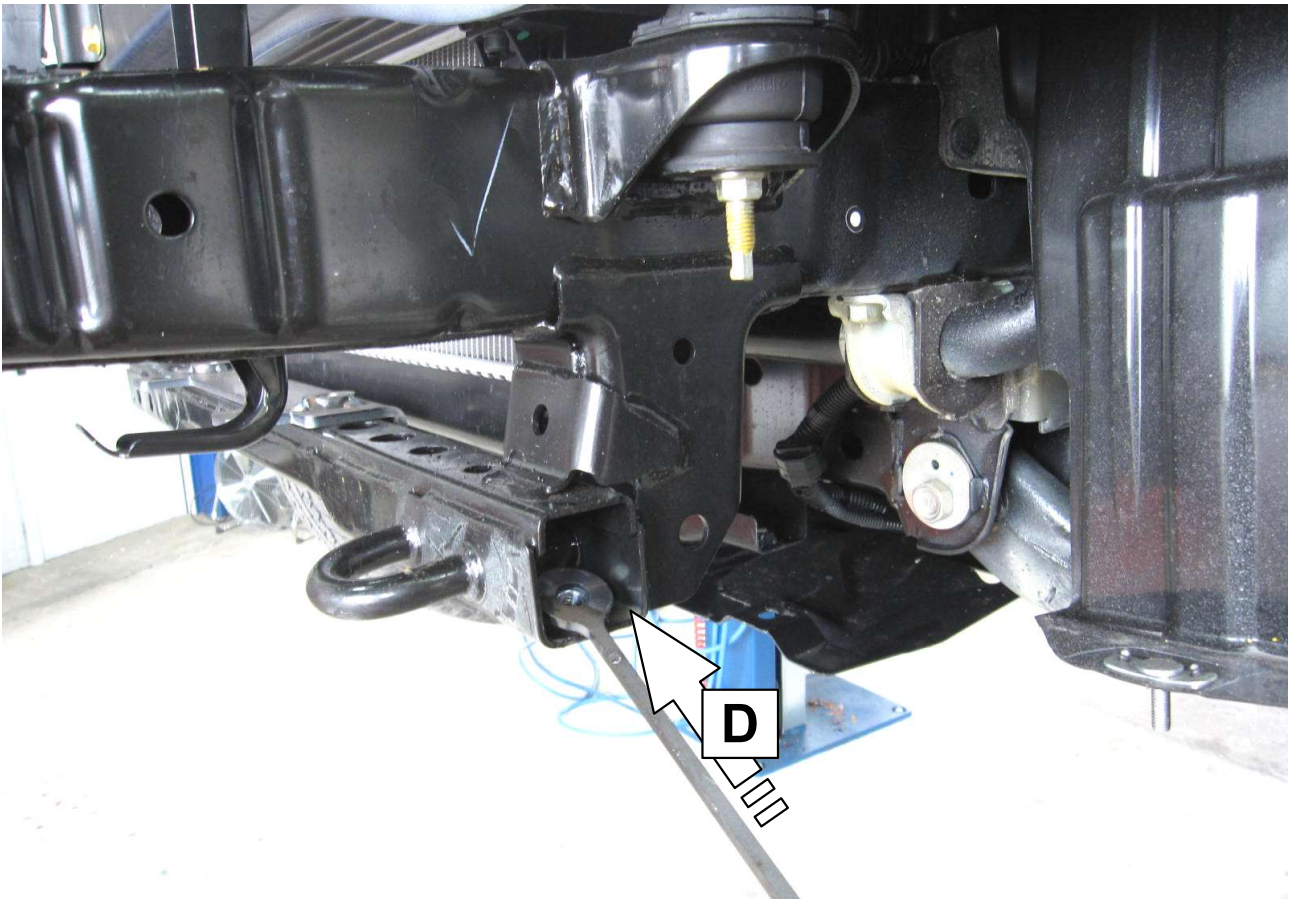

15

Das Gleiche an der rechten Seite / The same at the right!



16

Haltewinkel jetzt festziehen! / Tighten the bracket now!

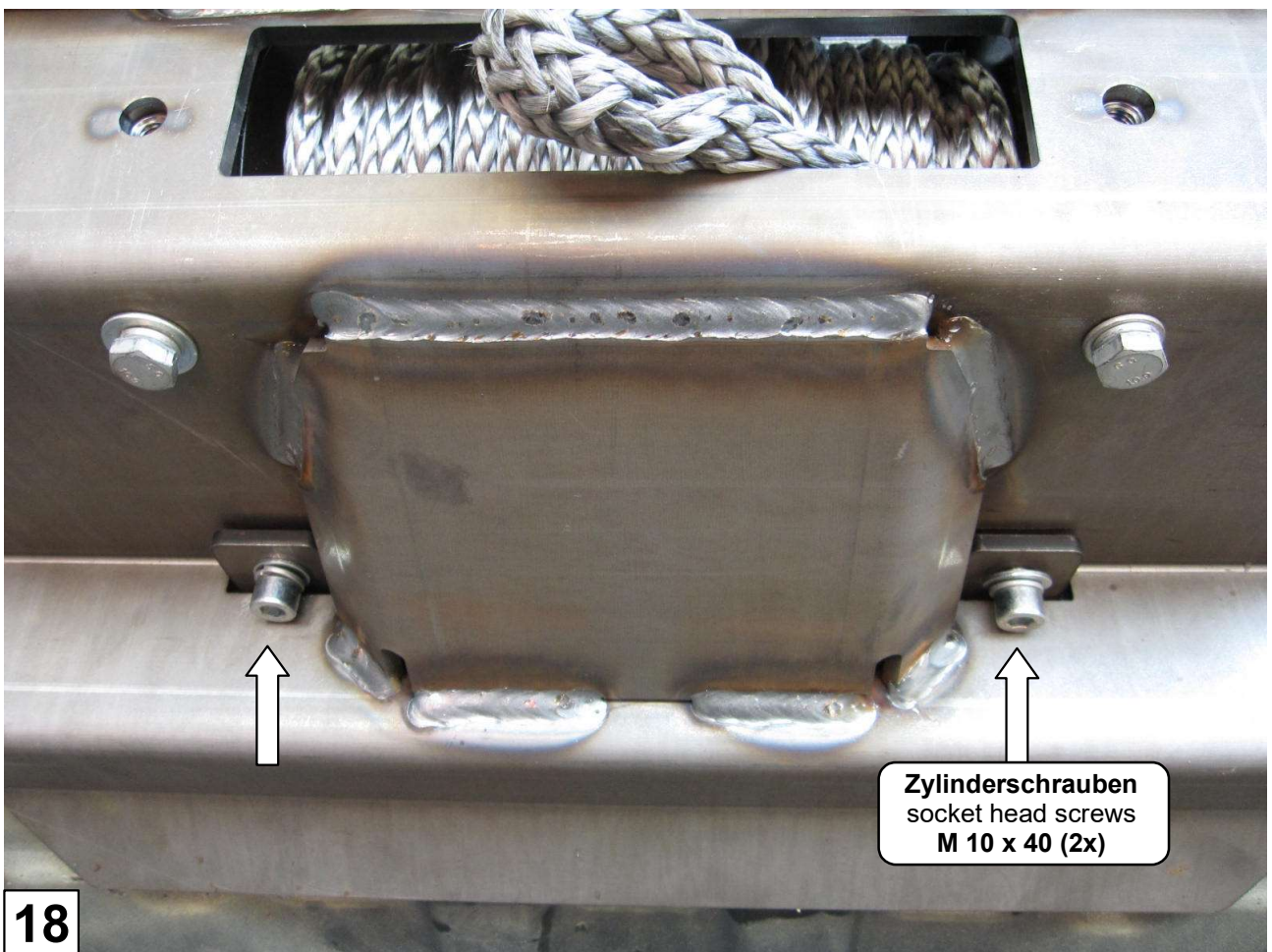
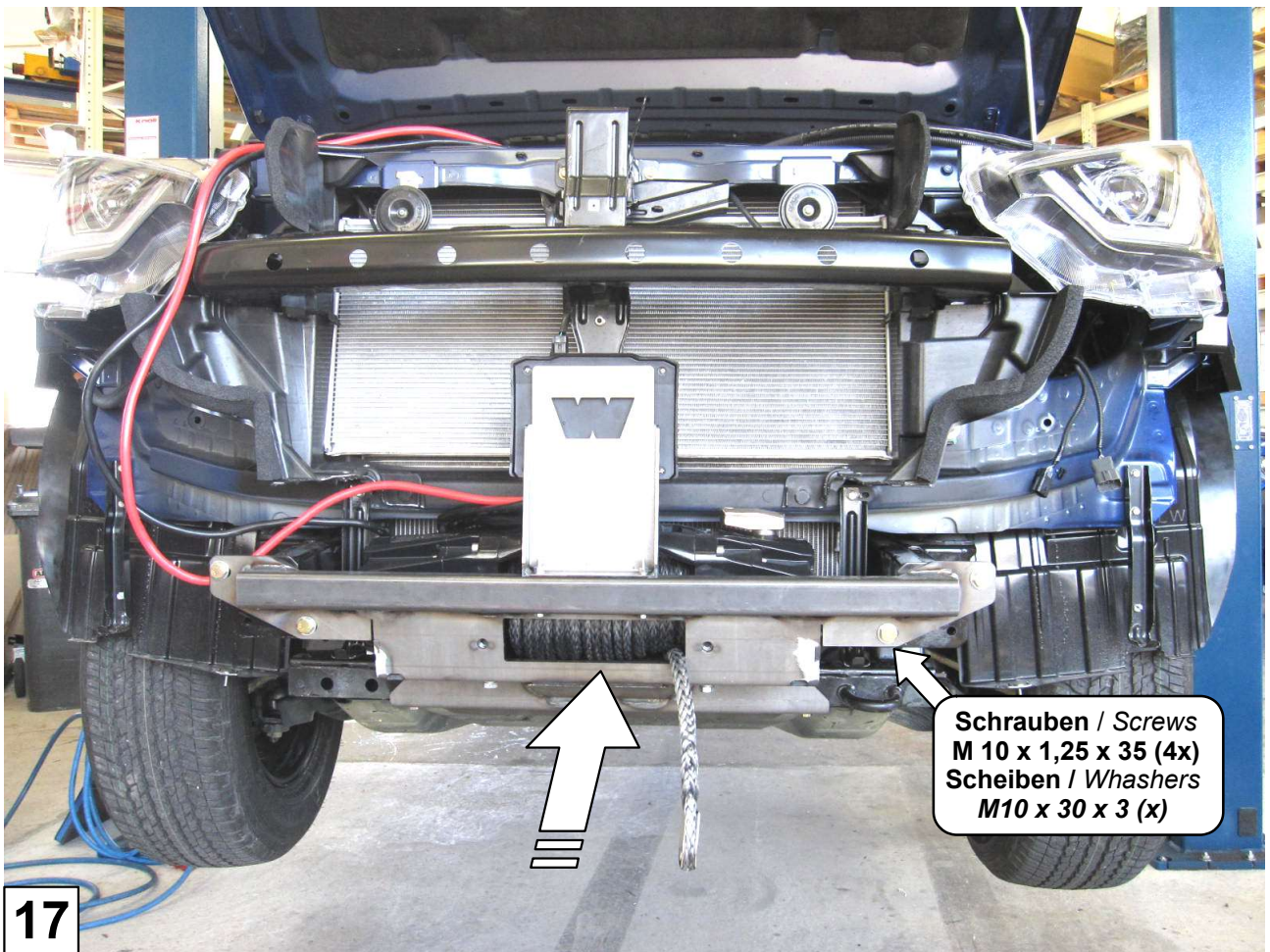

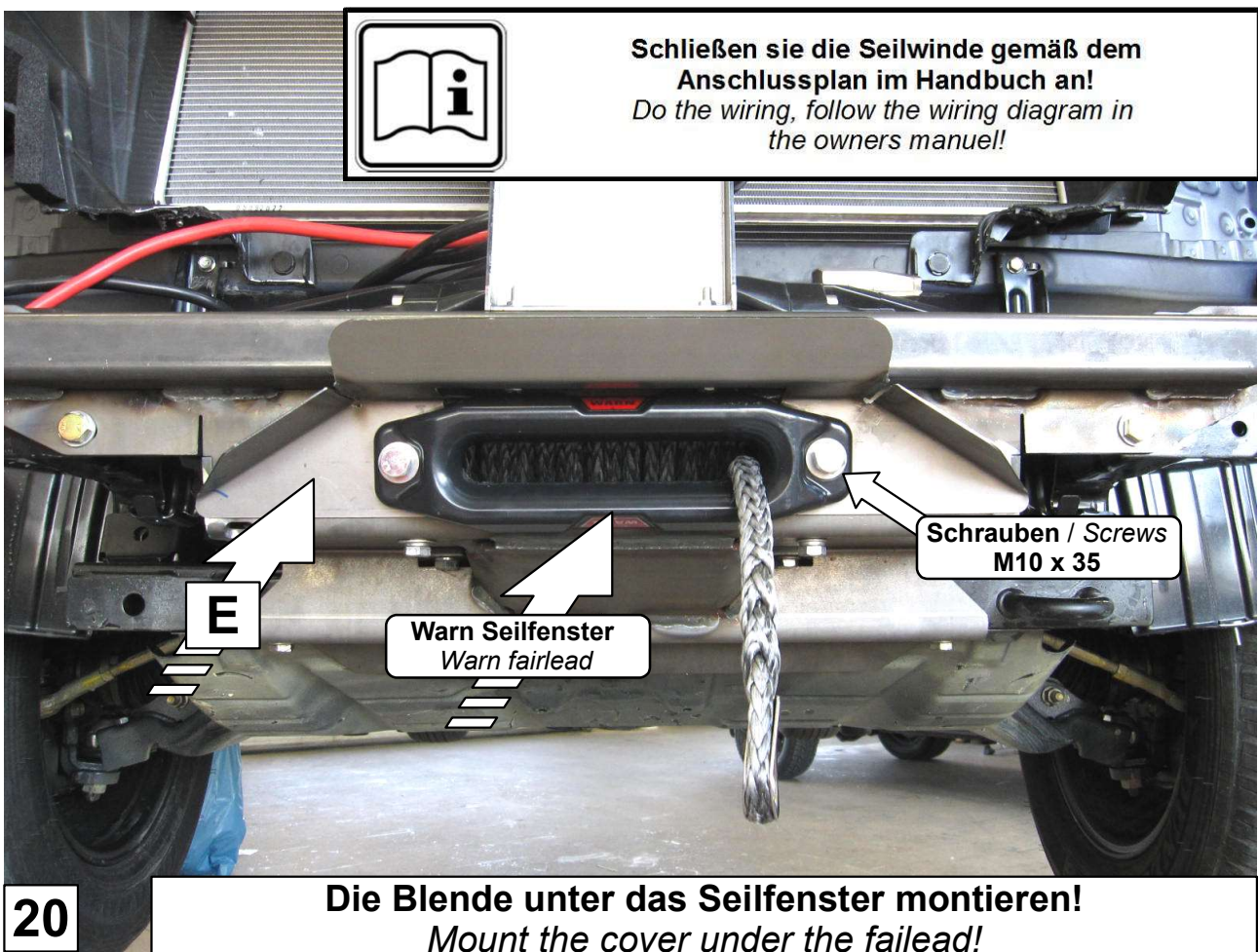
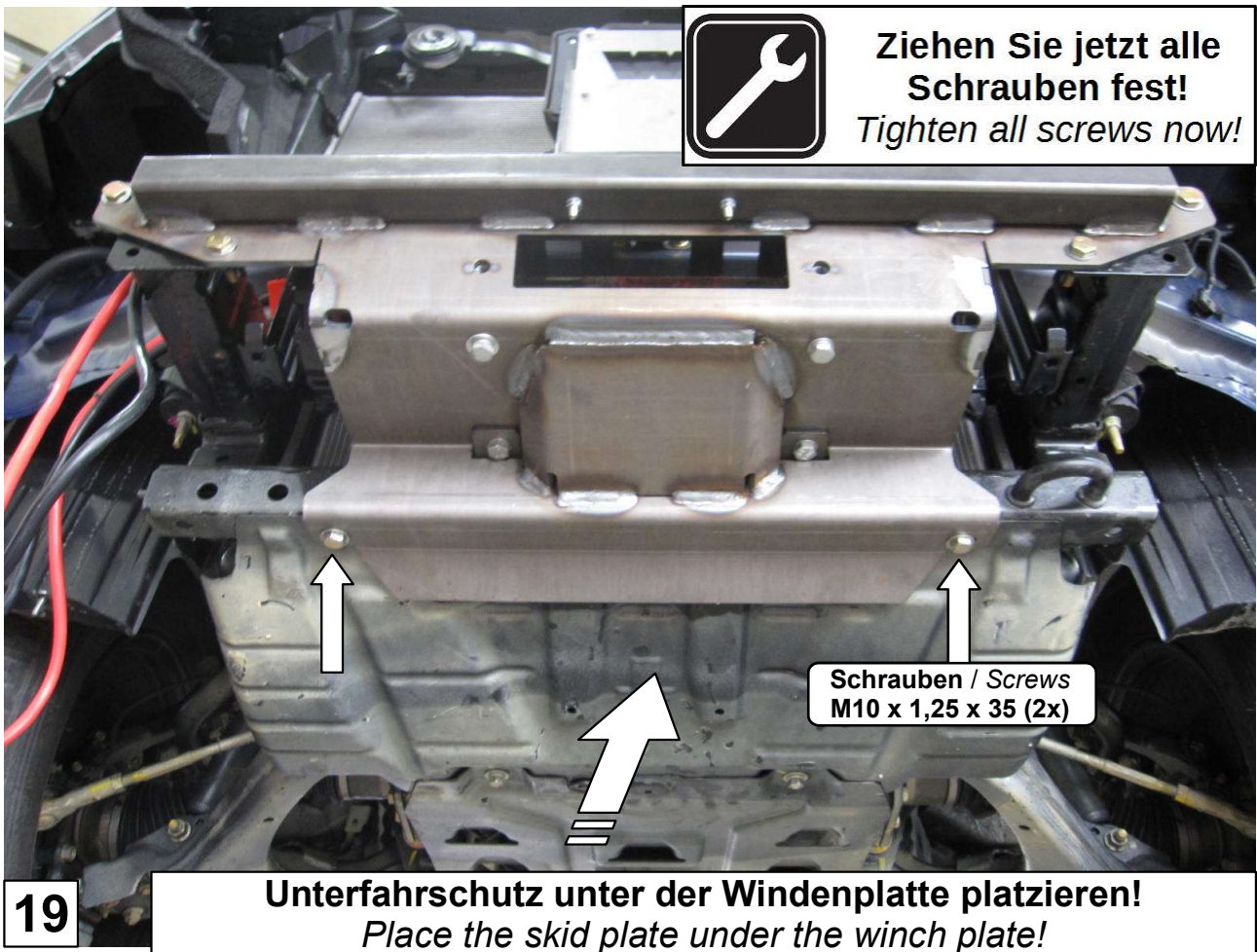

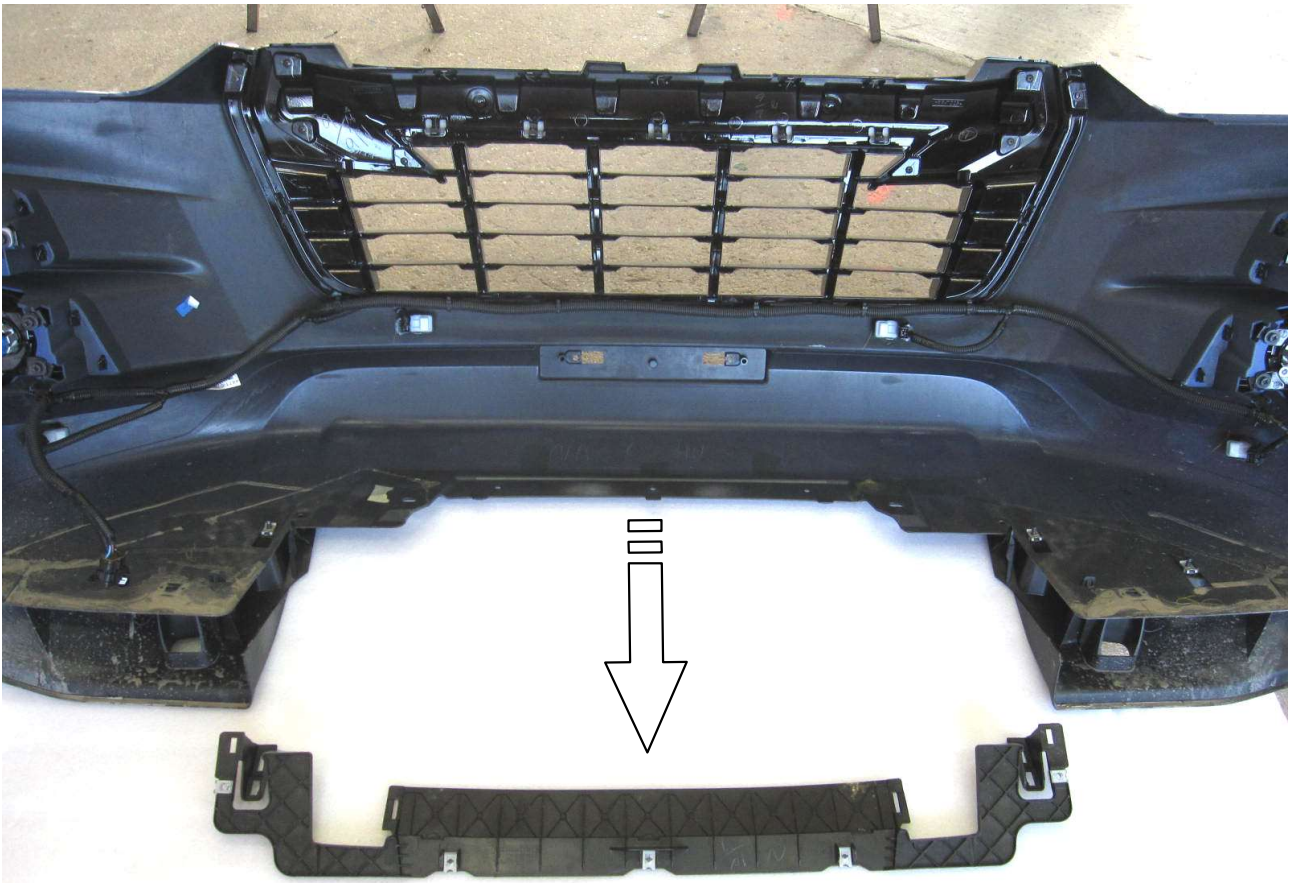

21

Innenteil unten ausbauen! / Remove the lower inner part!



22

**Ausschnitt anzeichnen und ausschneiden!
Mark out the cutout and cut it out!**



23

Rippe herausschneiden! / *Cut out the rip!*

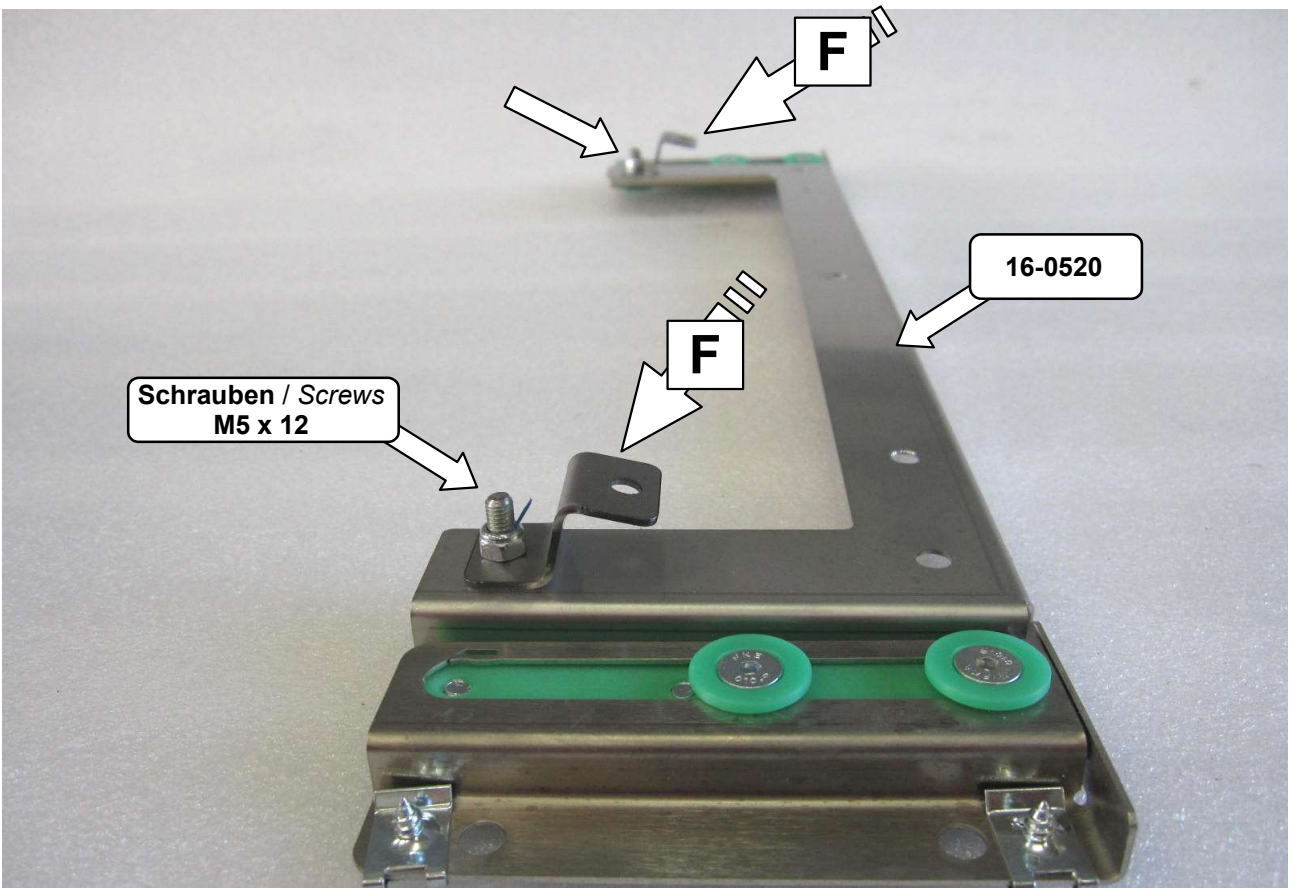

24

Distanzwinkel an Kennzeichenhalter montieren!
Mount the distance bracket on the licence plate holder!



25

Bohrungen anzeichnen und mit $\varnothing 6$ bohren!
Mark the holes and drill them with $\varnothing 6$!



26

Distanzen abschneiden / *Cut off the spacer sleeves!*

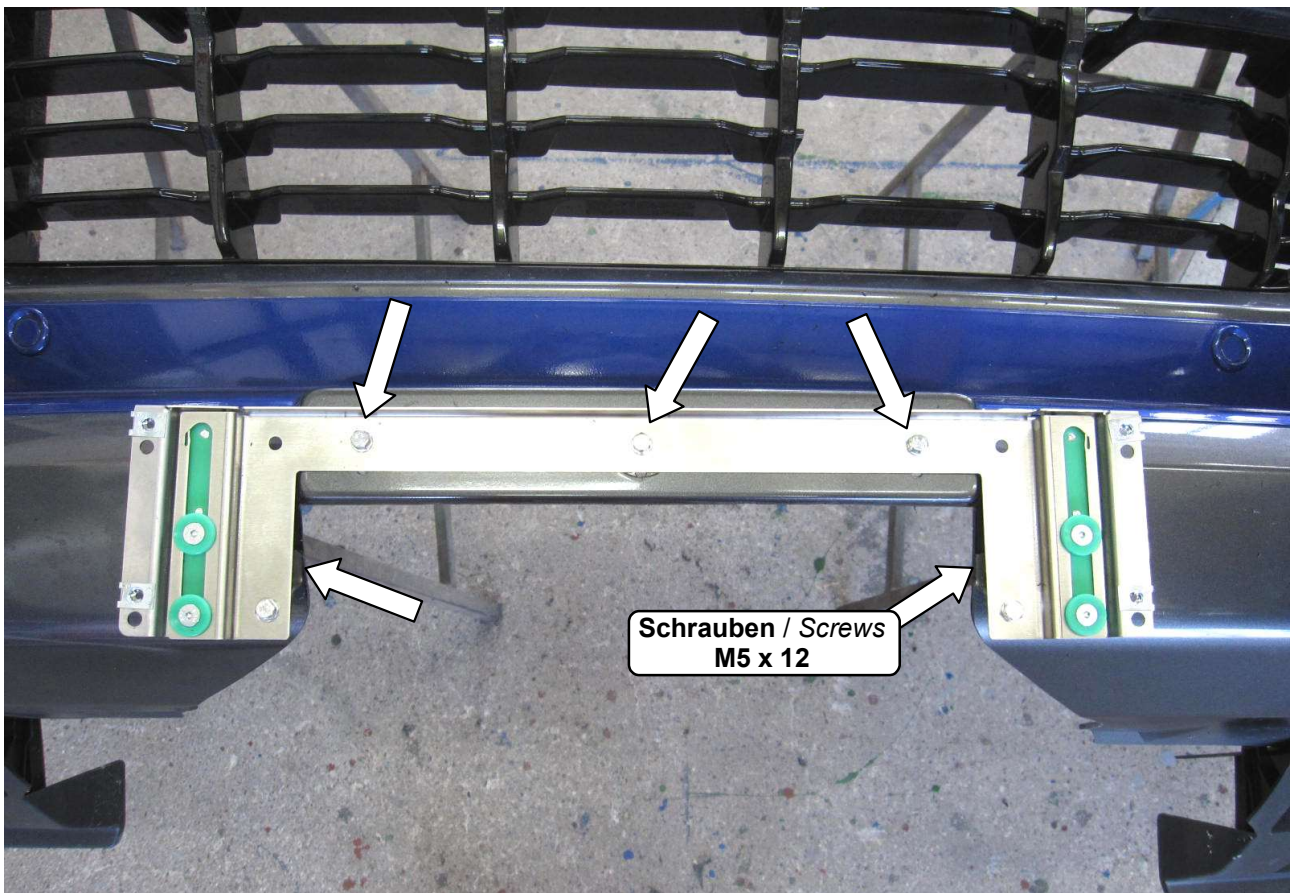

27

Kennzeichenhalter verschrauben!
Screw on the license plate holder!



28

Kennzeichenunterlage und Kennzeichen montieren!
Mount license plate base and license plate!



29

Stoßfänger wieder montieren! / Mount the bumper again!



30

**Oberen Teil des Kühlergrills und die Abdeckung wieder montieren!
Remount the upper part from radiator grille and the cover!**



31

Seilhaken montieren und in die Abschleppöse einhängen!
Mount the rope hook and hang it in the towing eye!



Schrauben Anzugsmomente	
Schraubengröße	Güteklasse - 8.8
M6	10 Nm
M8	25 Nm
M10	50 Nm
M12	87 Nm
M14	138 Nm
M16	210 Nm

32

Fertig / finish