

Anbauanleitung: Seilwindenanbausatz Ford Ranger ab2019

AL: 2215-02

Best.Nr.: 16-8330

Montagezeit: ca. 6 Std.

***Hier sehen sie den fertig montierten Seilwindenanbausatz.
Bevor sie mit der Montage beginnen, lesen sie bitte diese Anleitung und das
Benutzerhandbuch der Seilwinde gut durch.***

Before you start fitting, please read and understand this instruction manual and the owners manual of the winch.



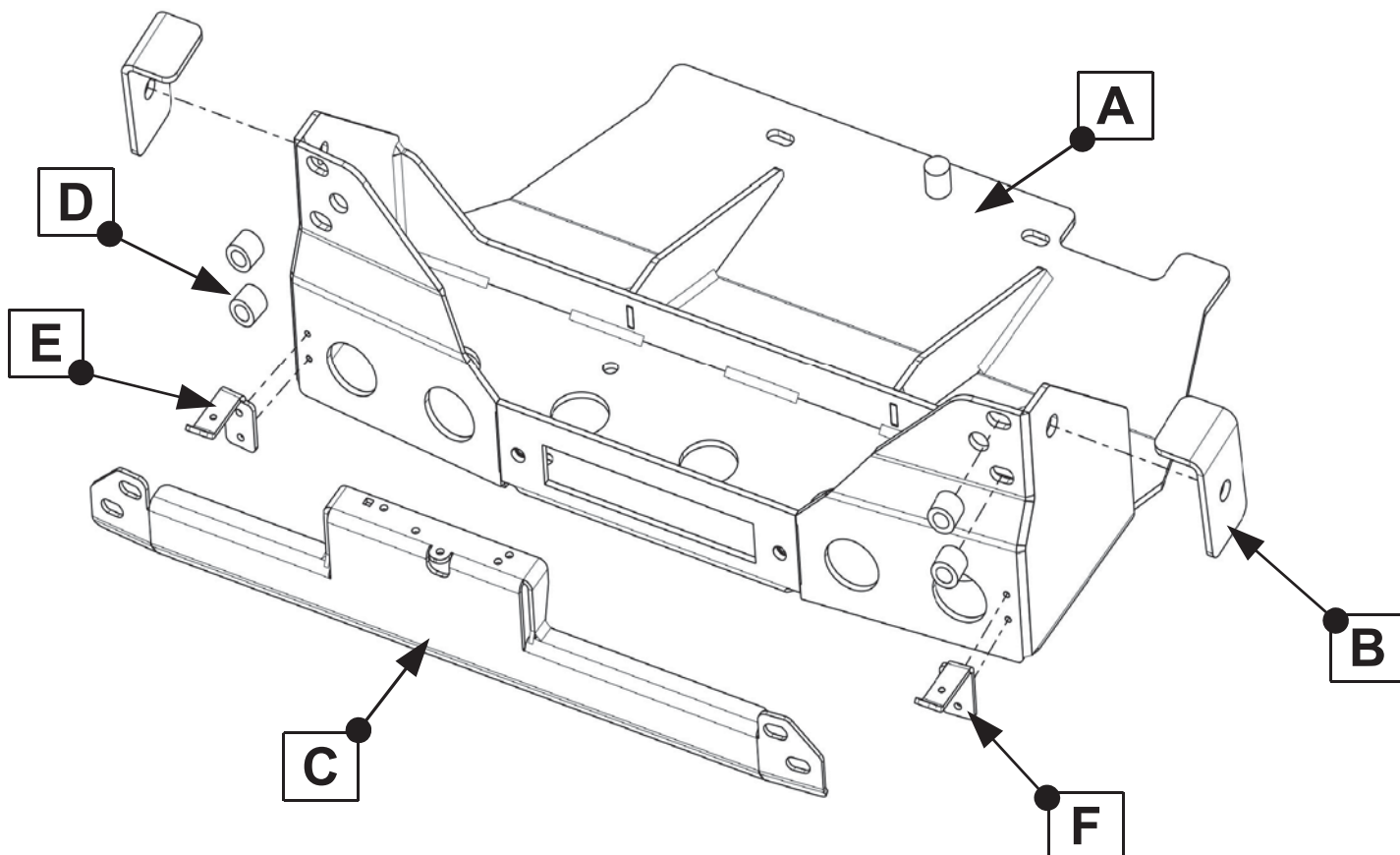

Stückliste

16-833

Schraubensatz

1x Windenaufnahme (A)
 2x Winkel (B)
 1x Sensorhalter (C)
 4x Distanz (D)
 1x Befestigungswinkel rechts (E)
 1x Befestigungswinkel links (F)

1x 16-2190,
 Sicherungskit für alle Fahrzeugwinden
 ab 3,6t, inkl. 500A Sicherung & Halter

1x Anbauanleitung 2215
 1x Gutachten+Aufkleber

2x Schraube M14 x 100
 4x Scheibe M14
 2x Federring M14
 2x Mutter M14

2x Schraube M10 x 35
 2x Scheibe M10
 2x Federring M10

4x Schraube M12 x 55
 8x Scheibe M12
 4x Federring M12
 4x Mutter M12

4x Schraube M6 x 20
 4x Scheibe M6
 4x Federring M6

2x Senkkopfschraube M10 x 35

Schrauben Anzugsmomente siehe letzte Seite!
For torque information please see last page!

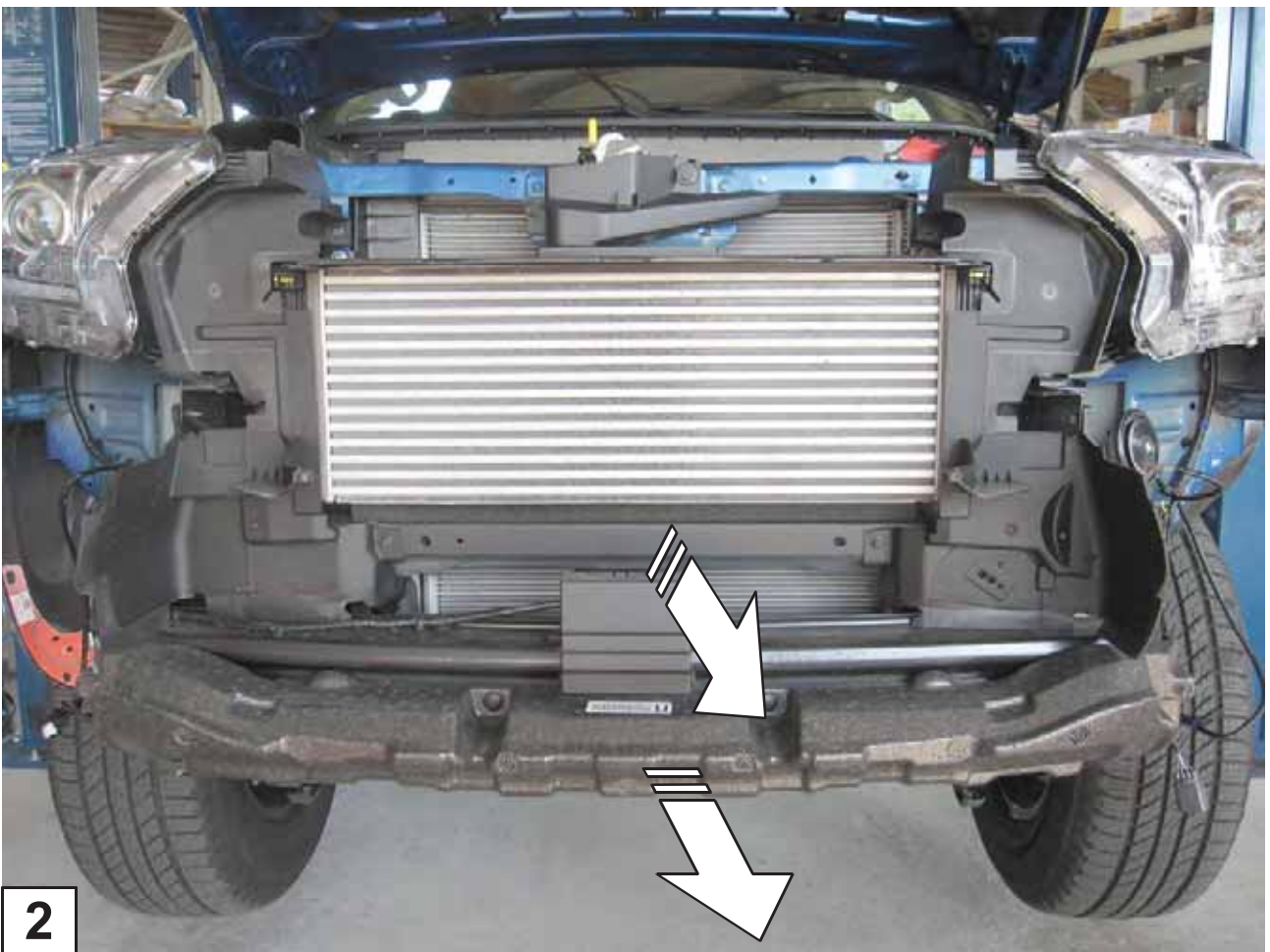

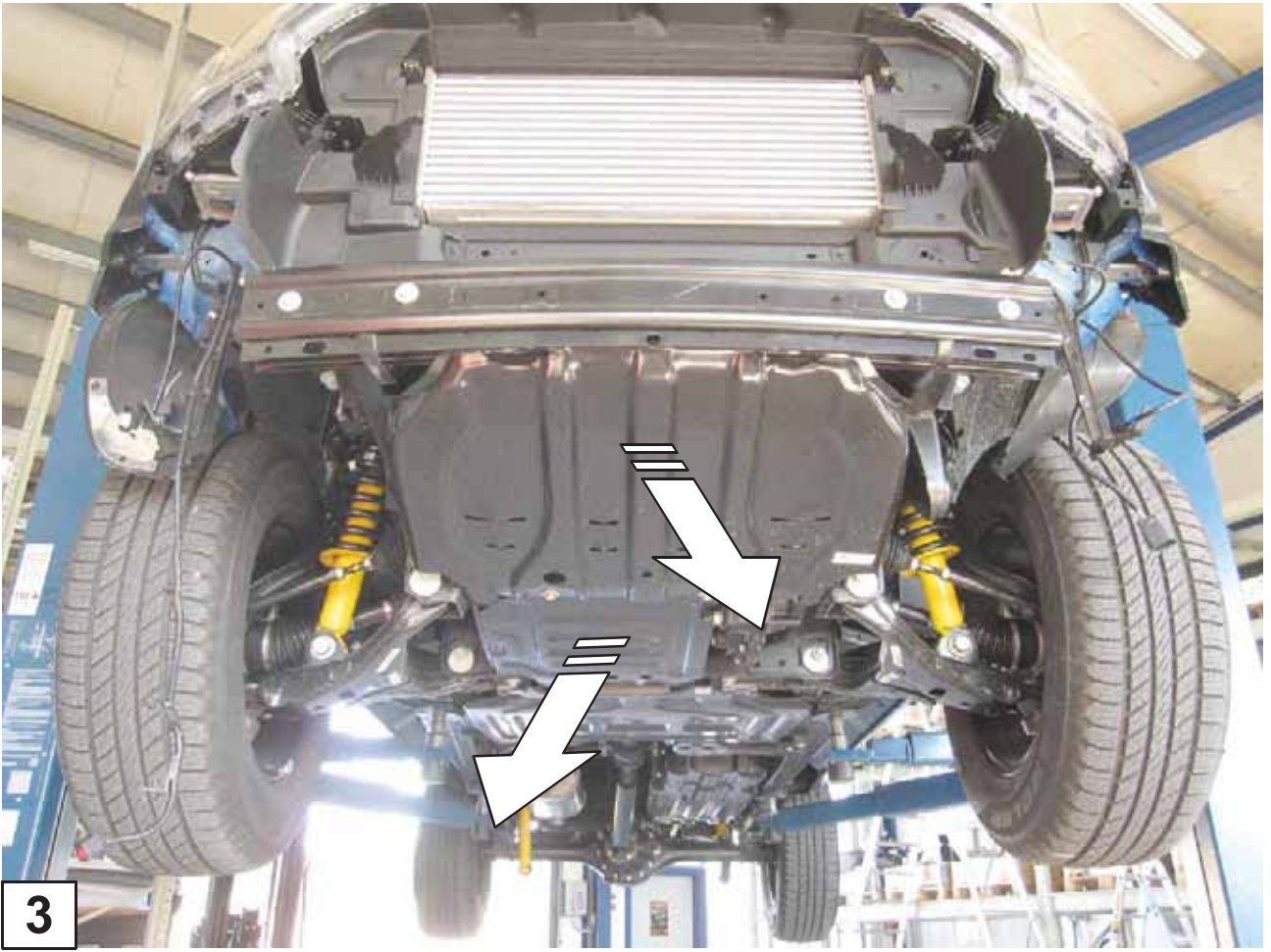

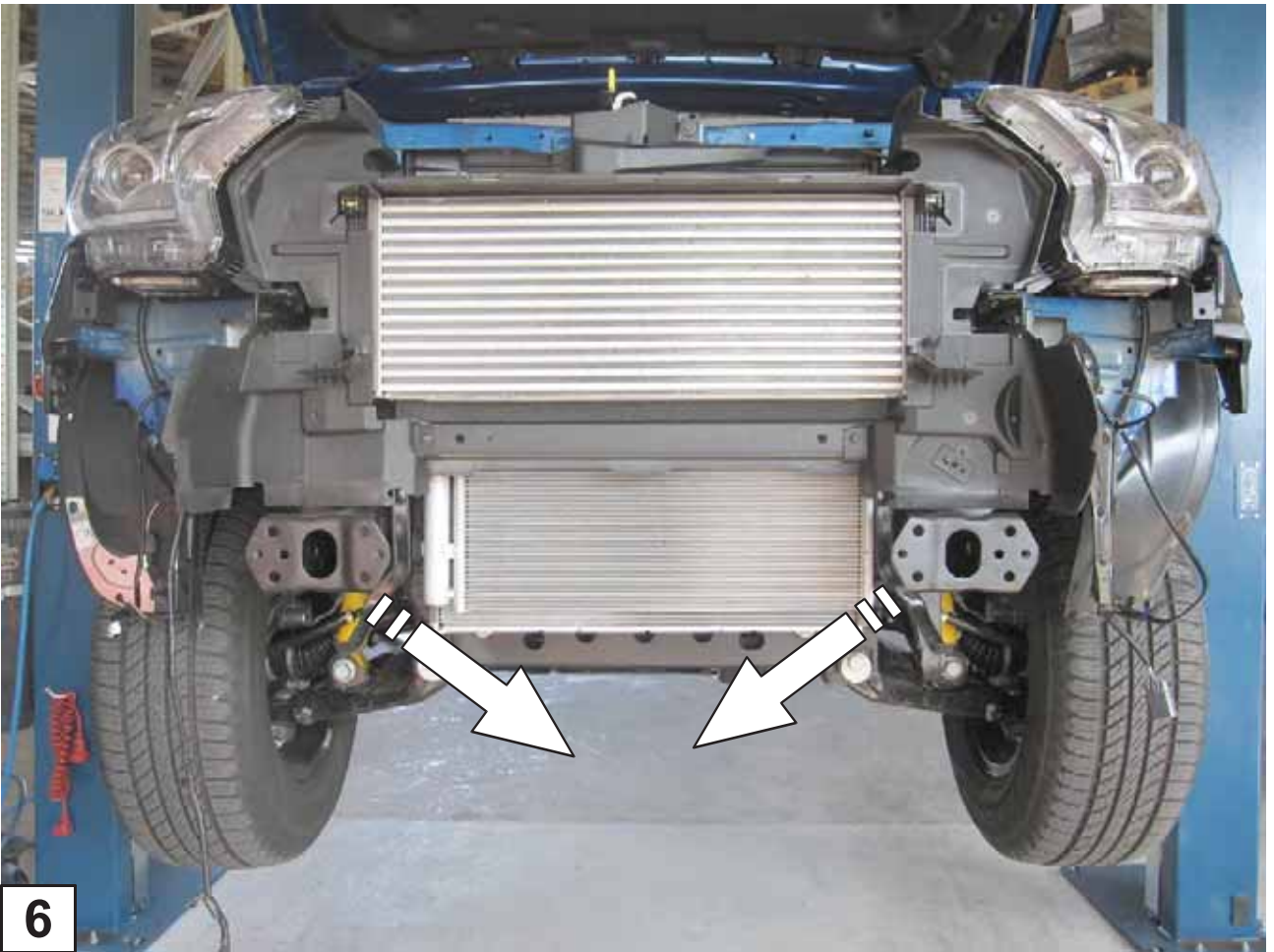



Einbauanleitung der Seilwinde beachten!

Please follow installation manual of the winch!

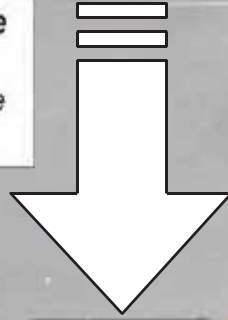

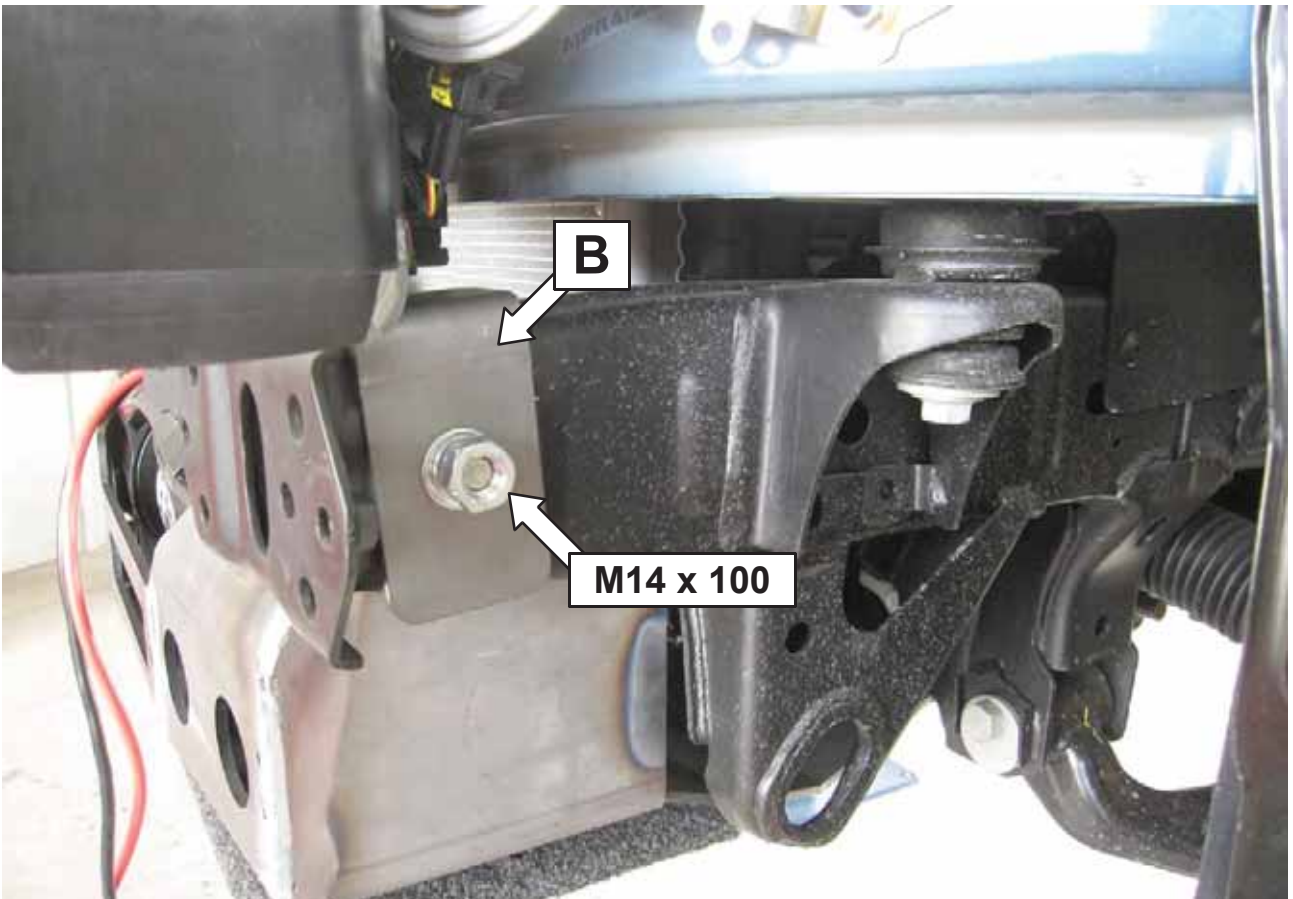

9 Das Gleiche an der Rechten Seite! / *The same at the right side!*

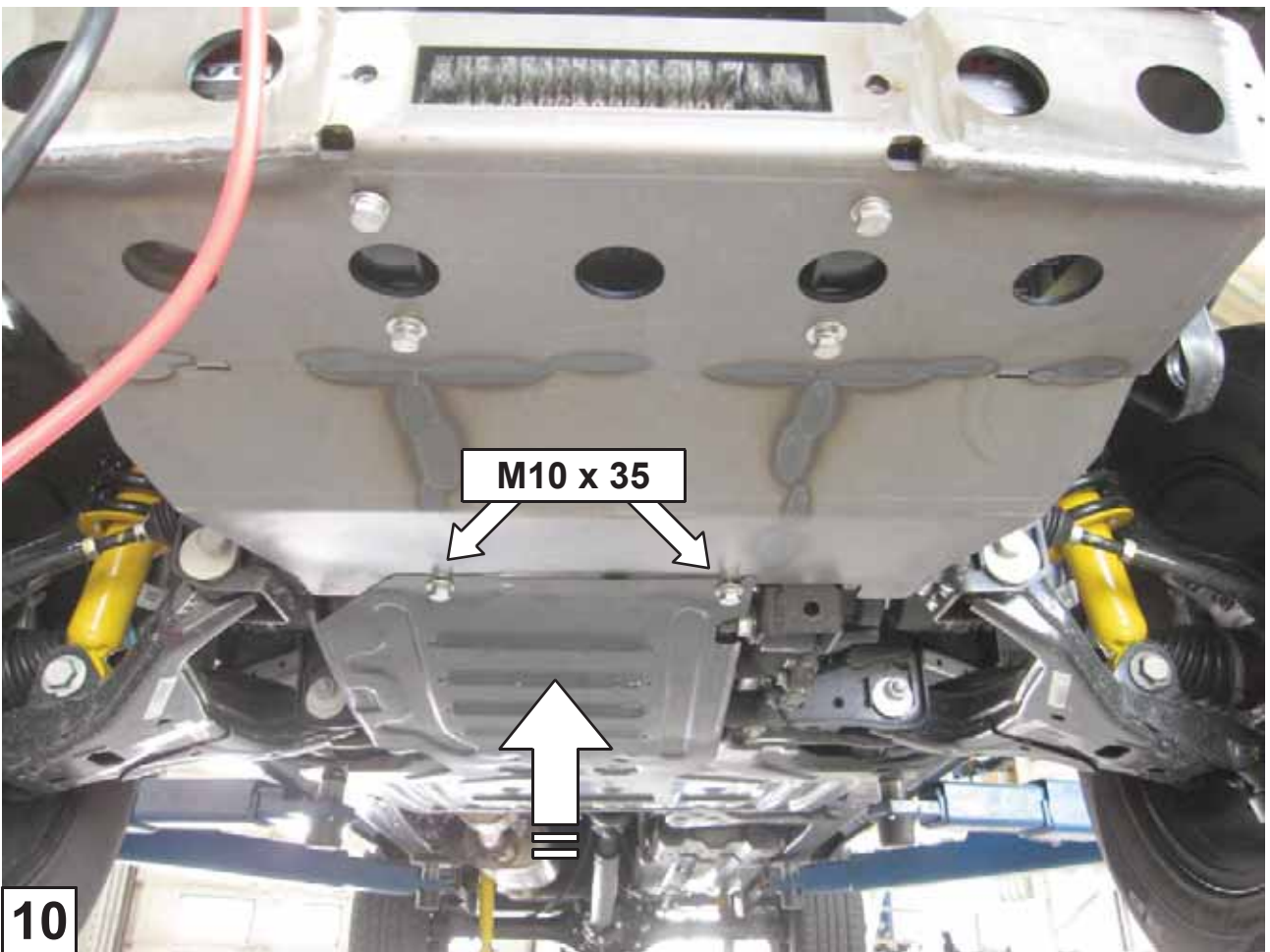

10

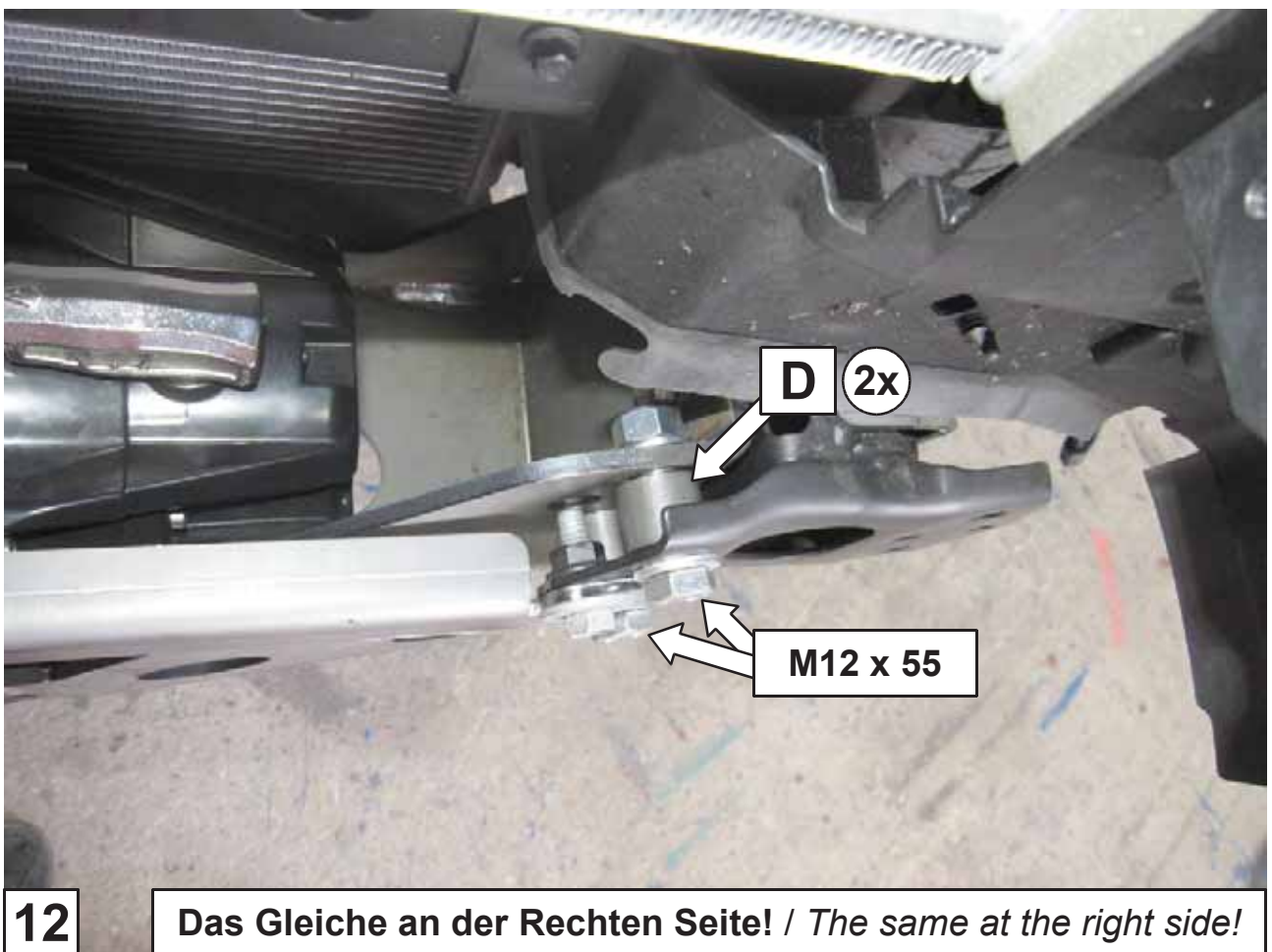
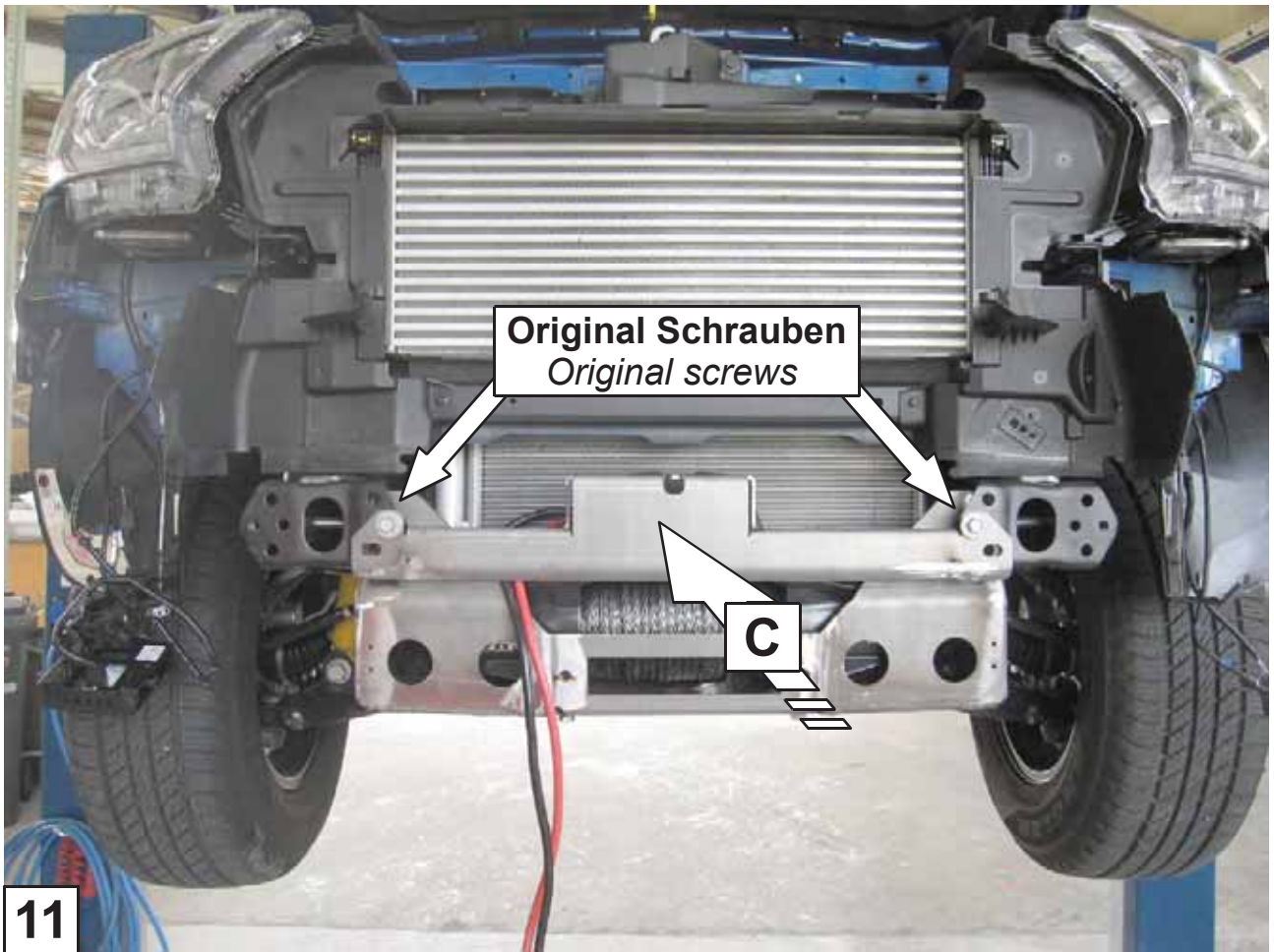



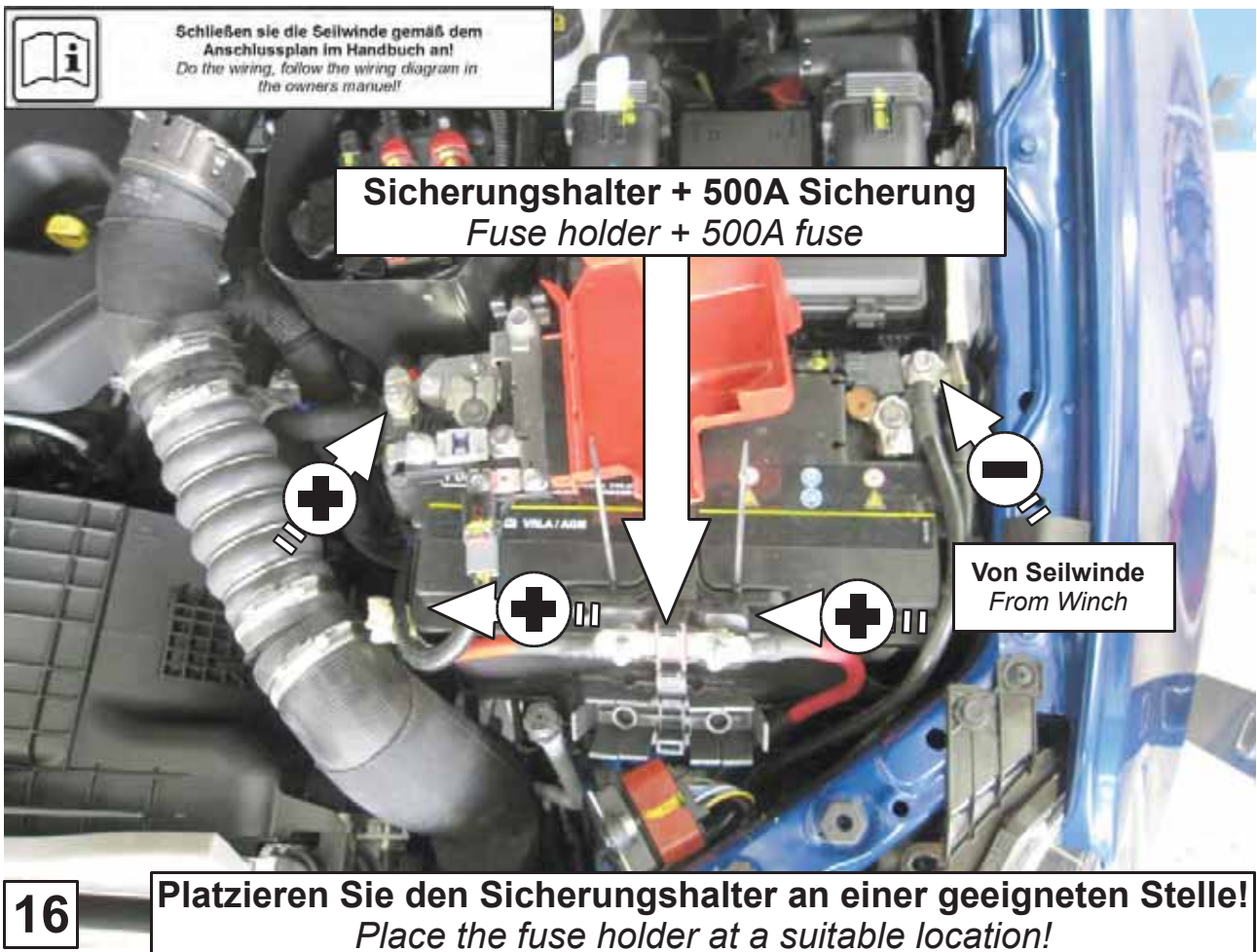
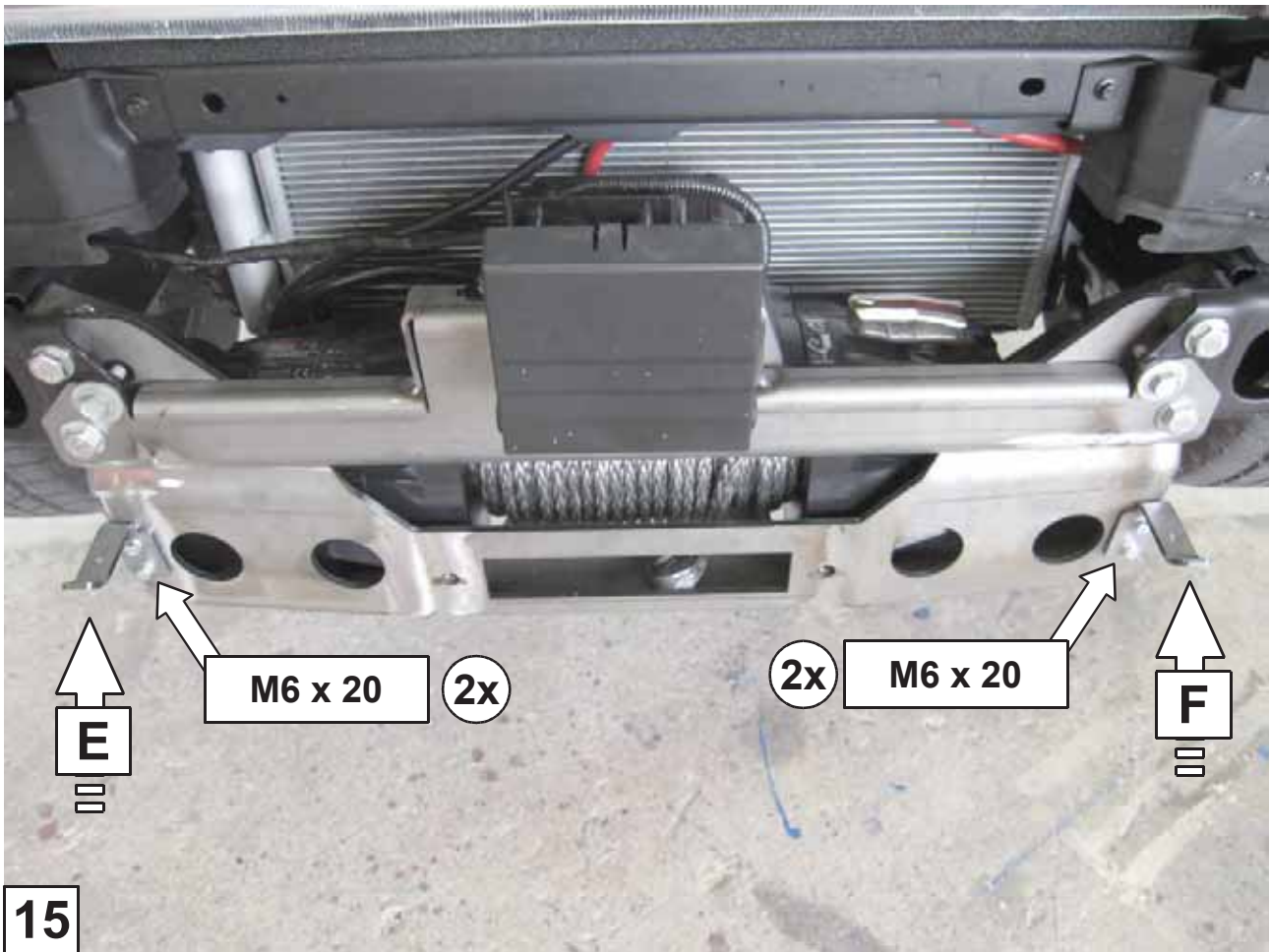





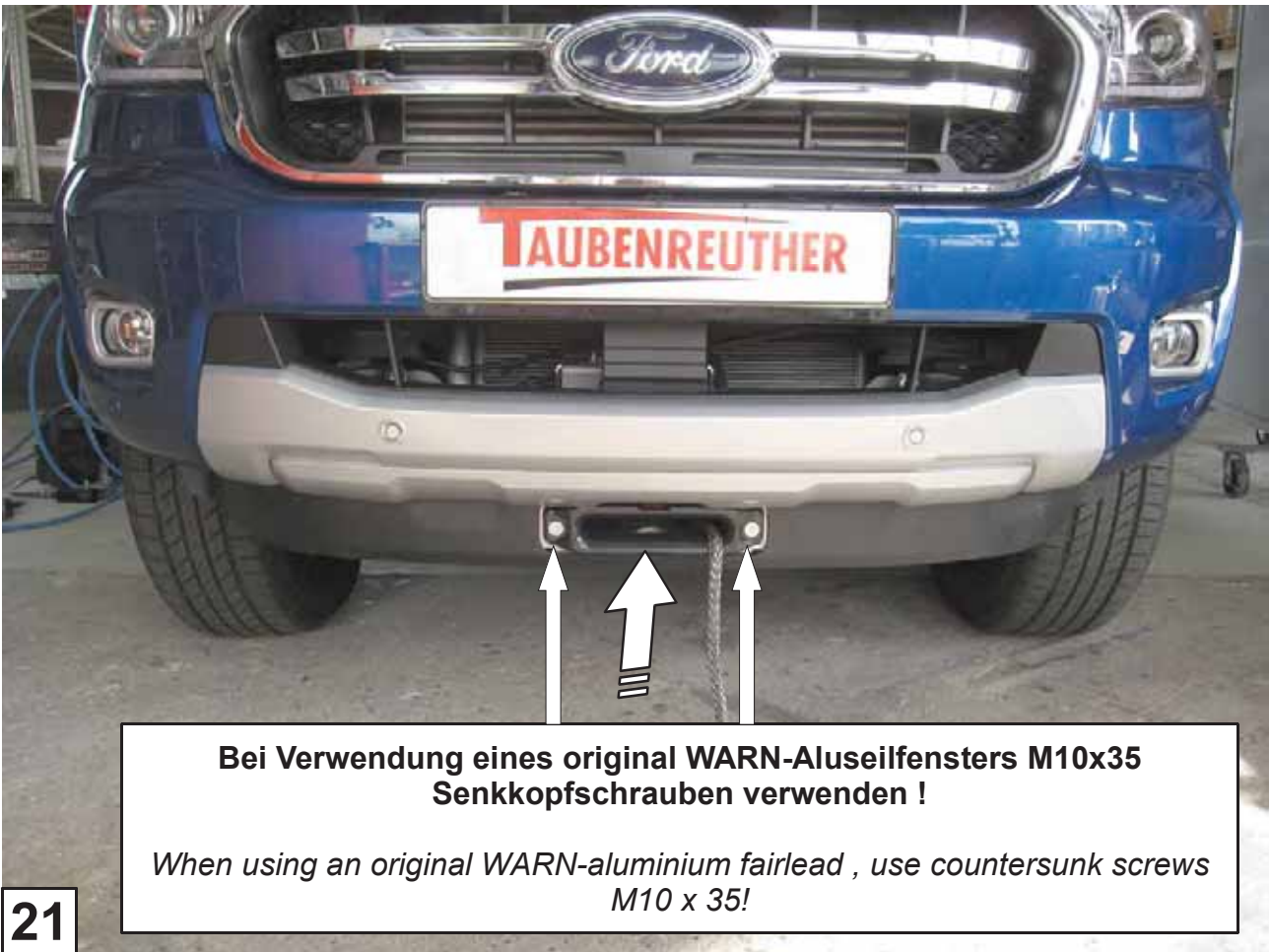





23

Position Seilhaken nicht für den öffentlichen Straßenverkehr!
*Hook position **not** for public traffic!*



24

Position Seilhaken für den öffentlichen Straßenverkehr!
Hook position for public traffic!



Schrauben Anzugsmomente	
Schraubengröße	Güteklasse - 8.8
M6	10 Nm
M8	25 Nm
M10	50 Nm
M12	87 Nm
M14	138 Nm
M16	210 Nm