

**Anbauanleitung:** Seilwindenanbausatz

**AL:** 2147-00

**Best.Nr.:** 16-6030

**Montagezeit:** ca. 8 Stunden

***Hier sehen sie den fertig montierten Seilwindenanbausatz.  
Bevor sie mit der Montage beginnen, lesen sie bitte diese Anleitung und das  
Benutzerhandbuch der Seilwinde gut durch.***

***Before you start fitting, please read and understand this instruction manual and the owners  
manual of the winch.***



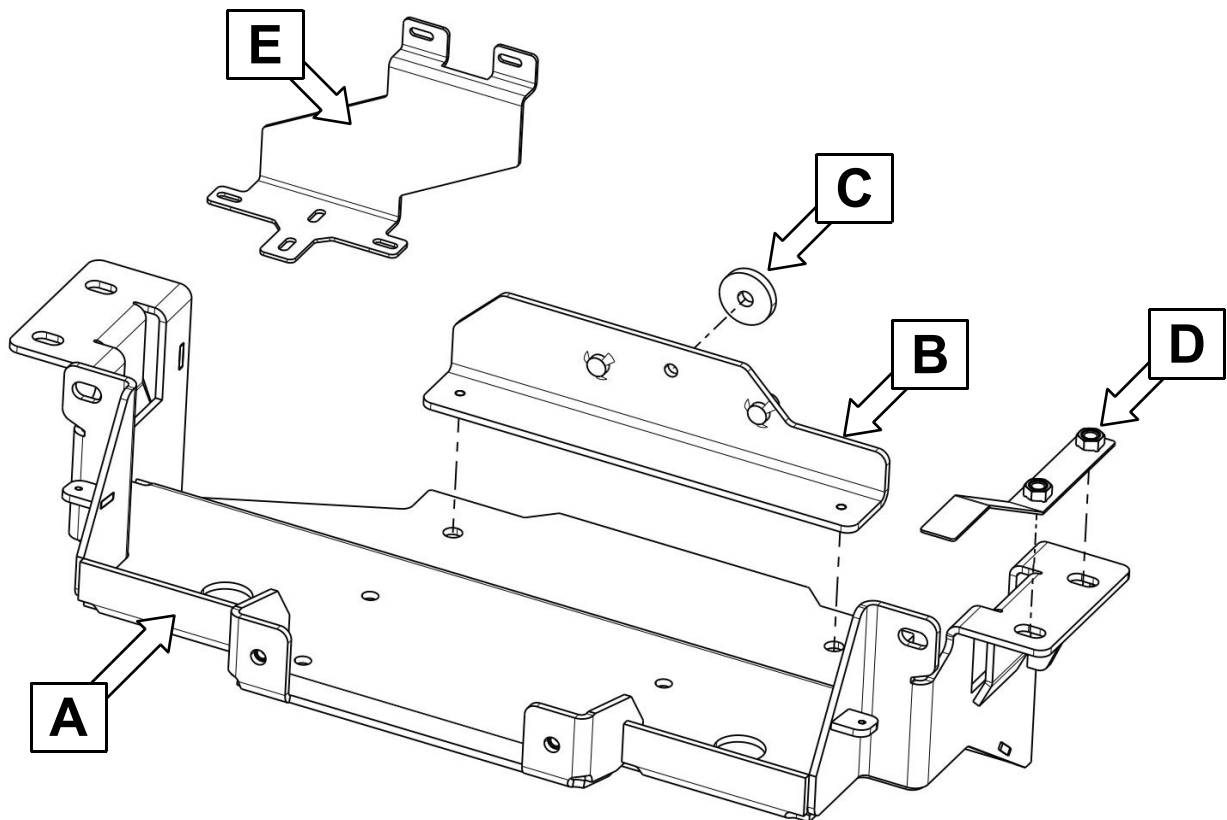

## Stückliste

\*\*\*16-6030\*\*\*

## Schraubensatz

1x 300mm Kabel 2,5<sup>2</sup> schwarz (A)  
 1x Ringkabelschuh M8 blau  
 1x Rundstecker blau  
 1x Rundsteckhülse blau

1x Windenträger (B)  
 1x Haltewinkel (C)  
 1x Beilage (D)  
 1x Befestigungsblech (E)  
 1x Schaltkastenhalter (F)

1x 16-0512 Kühlerschutzblech (G)  
 1x 16-0511 Freilaufhebel (H)  
 1x 16-05070 Freilaufhebelverlängerung (I)  
 600mm mit Gelenk

1x Anbauanleitung AL2147  
 1x Gutachten+Aufkleber

1x Schraube M10 x 120  
 2x Scheibe M10  
 1x Federring M10  
 1x Mutter M10

2x Schraube M12 x 1,25 x 50  
 2x Schraube M12 x 35  
 4x Scheibe M12  
 4x Federring M12

2x Senkscheibe M8 Alu  
 2x Senkschraube M8 x 25

4x Schraube M6 x 20  
 6x Scheibe M6  
 4x Federring M6  
 2x Mutter M6

2x Schraube M5 x 12  
 4x Scheibe M5  
 2x Federring M5  
 2x Mutter M5

**Schrauben Anzugsmomente siehe letzte Seite!**  
*Torque information see last page!*

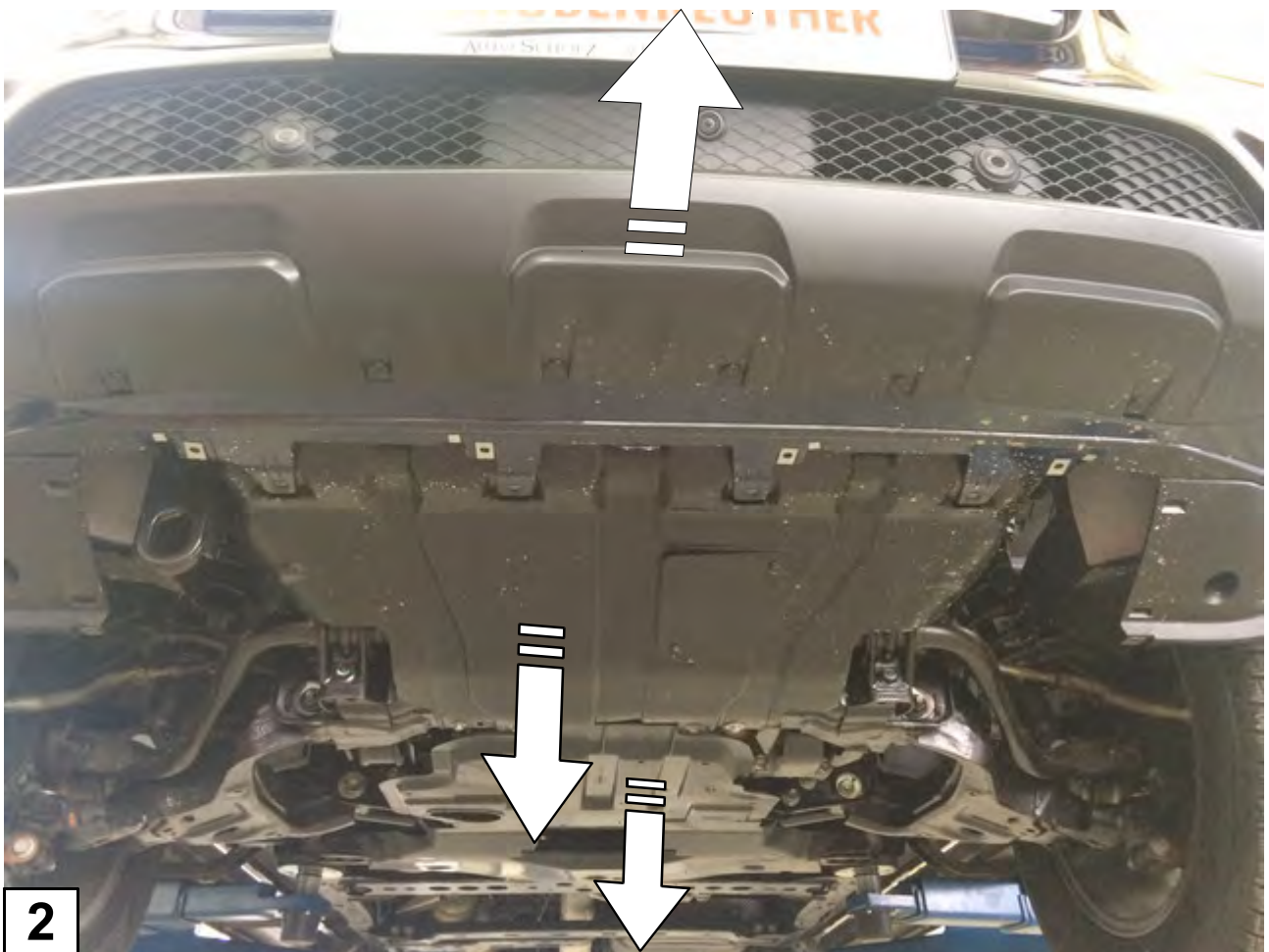



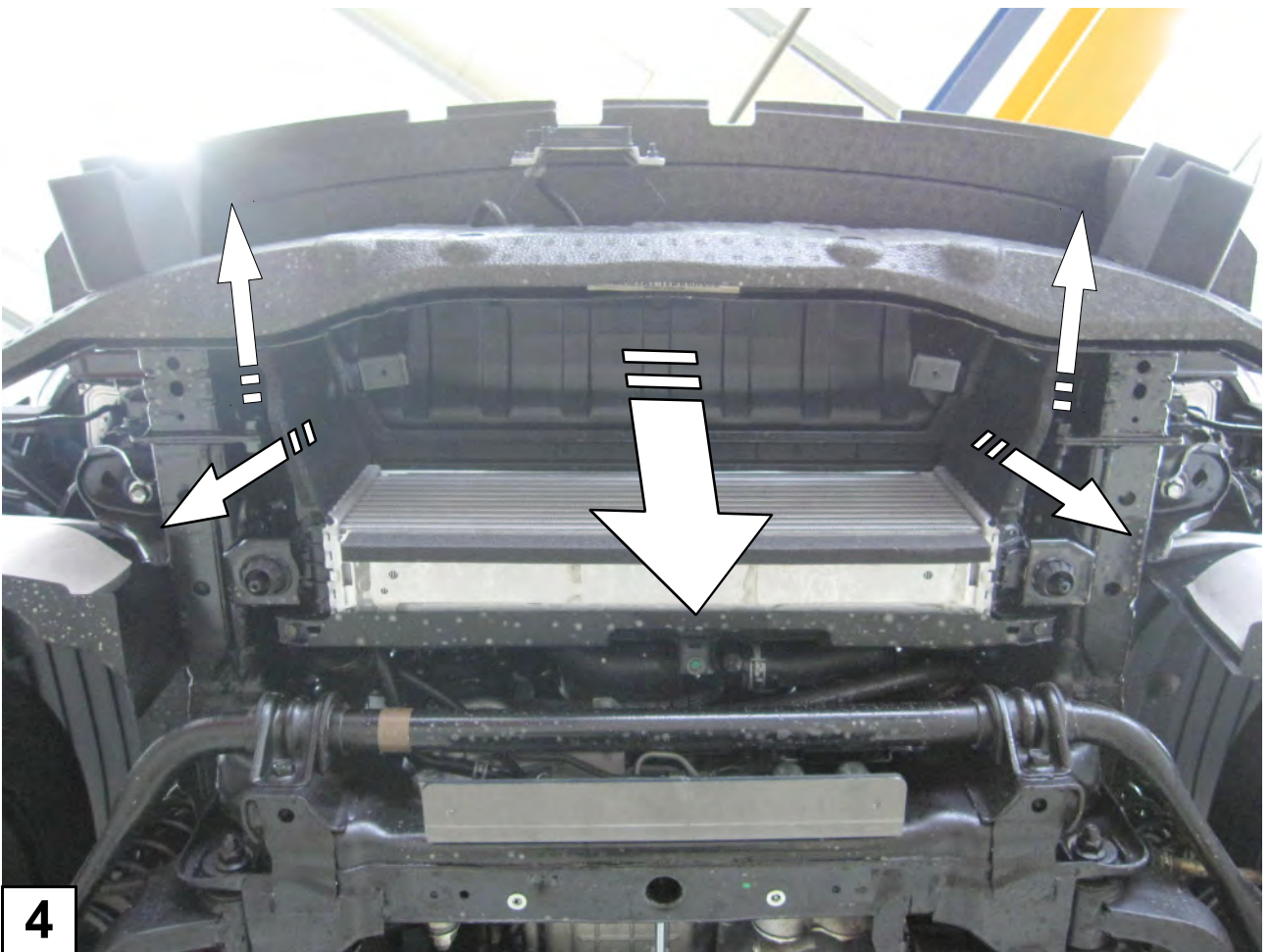



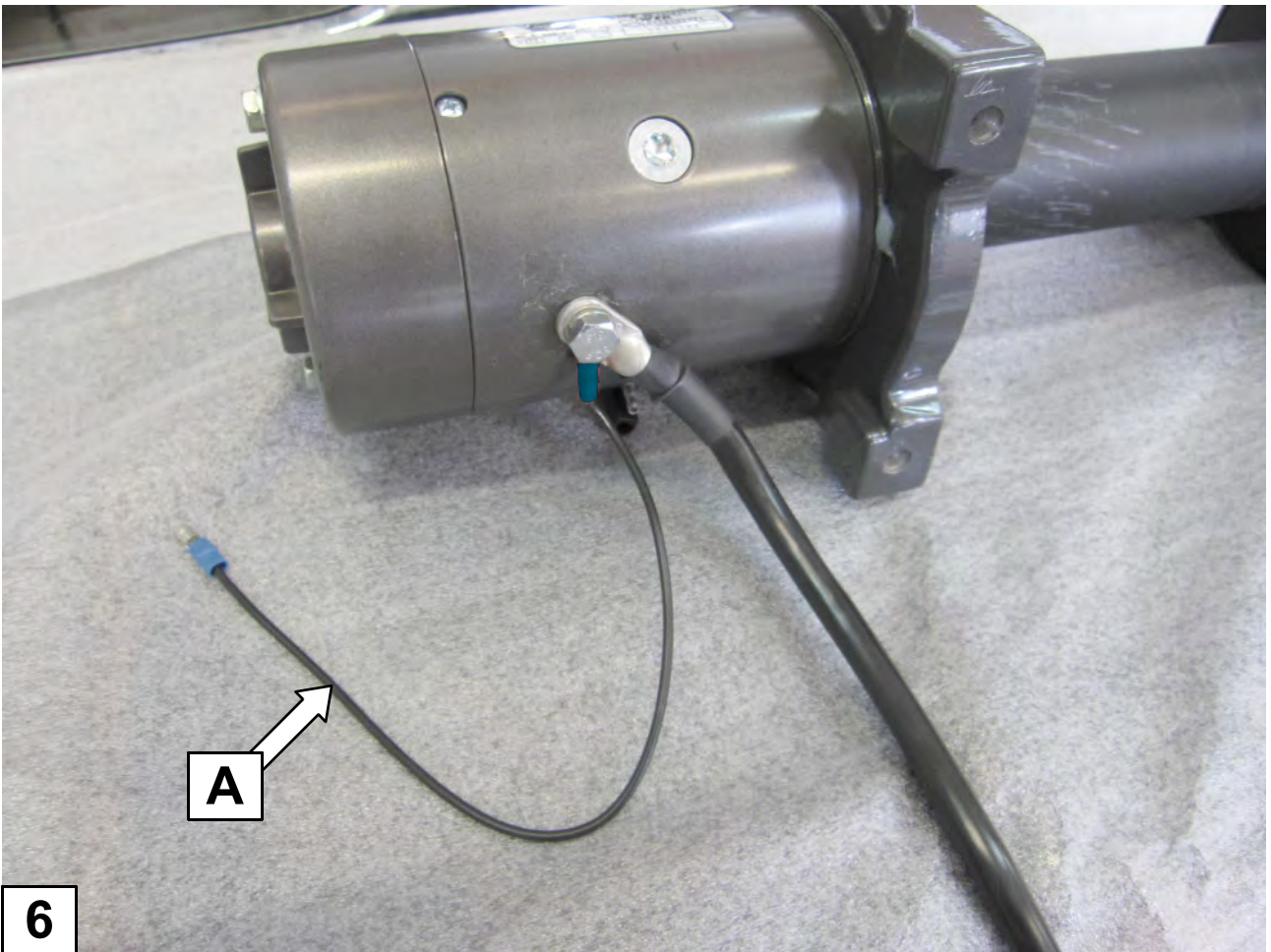
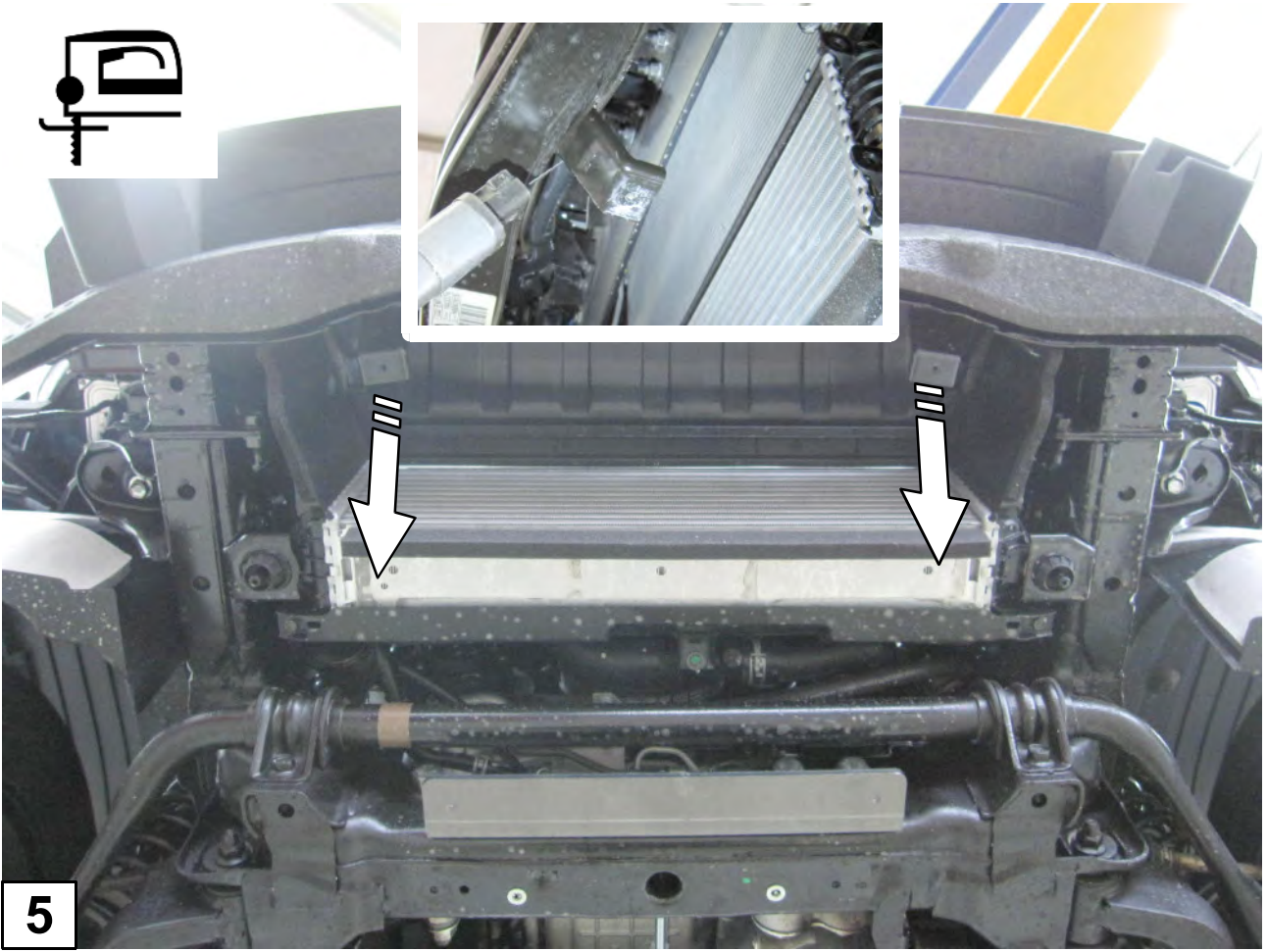





**Einbauanleitung der Seilwinde  
beachten!**

*Please follow installation manual of the  
winch!*

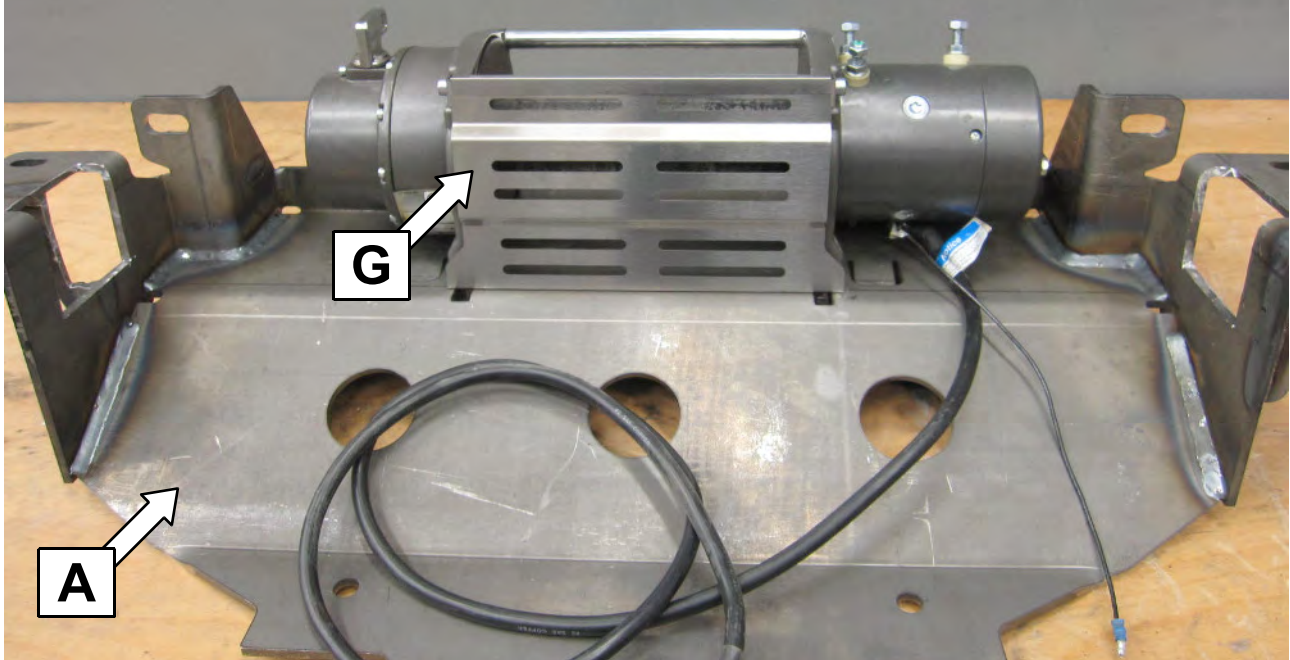

**7**

**Einbauanleitung 16-0512 beachten! / Observe manuel 16-0512!**

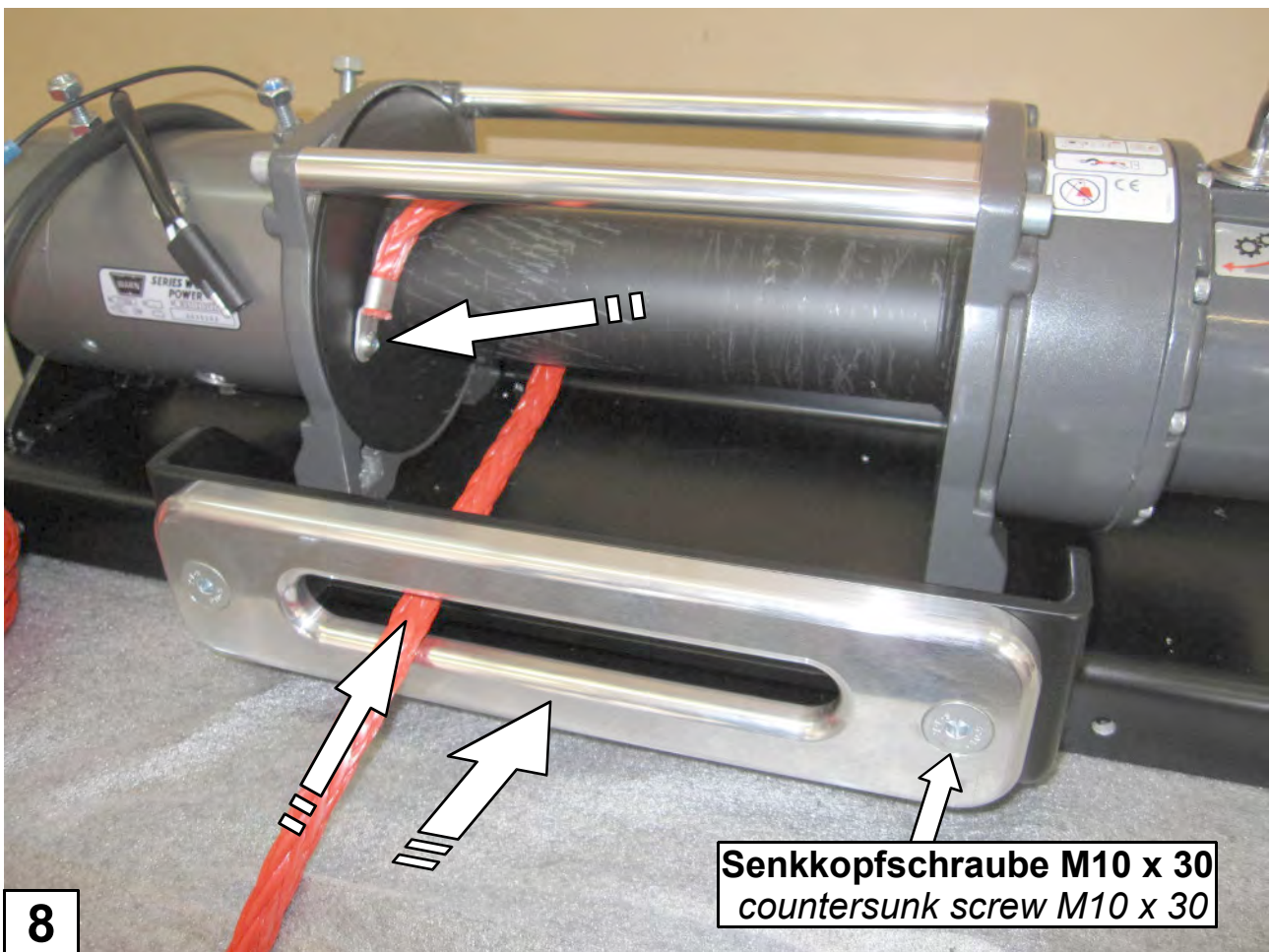

**8**

**Senkkopfschraube M10 x 30  
countersunk screw M10 x 30**

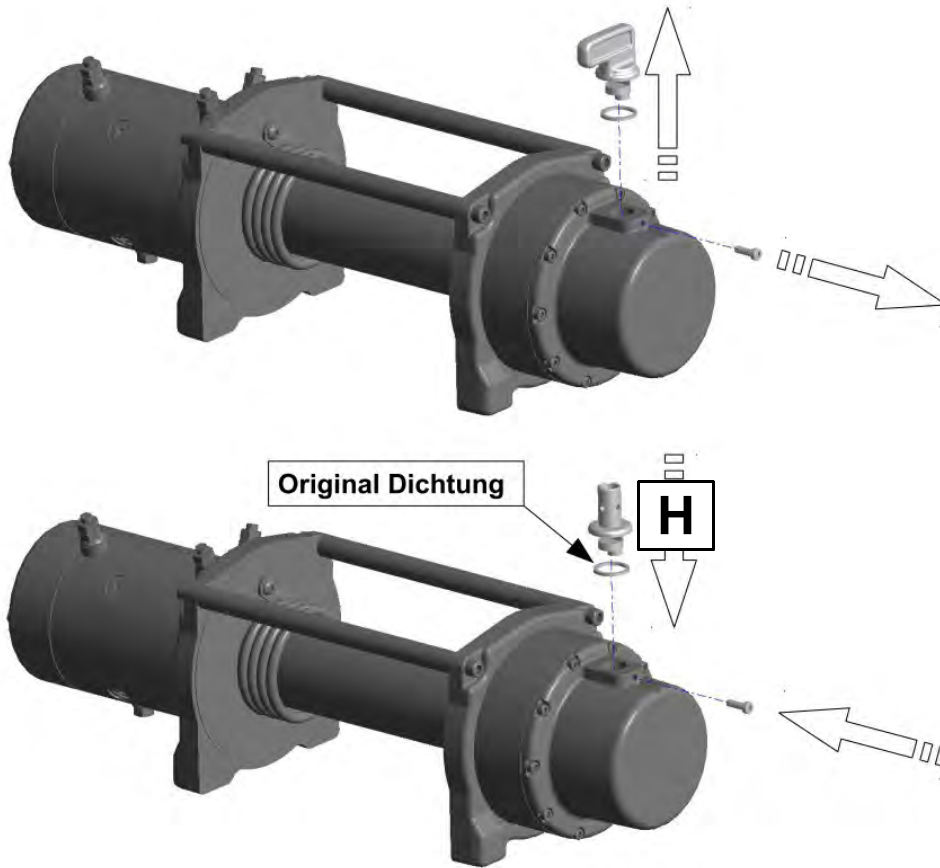

9

Einbauanleitung 16-0511 beachten! / Observe manuel 16-0511!

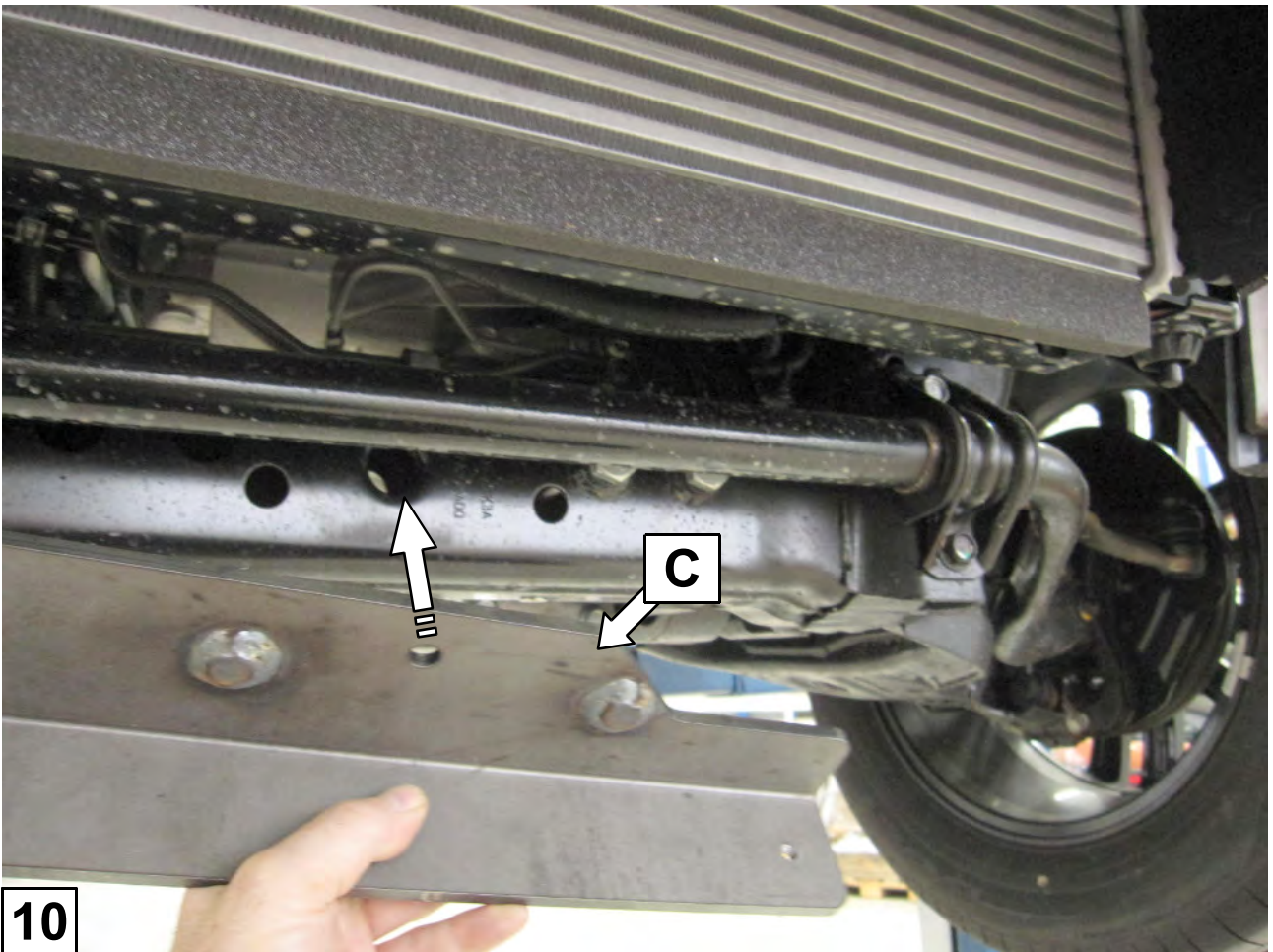

10



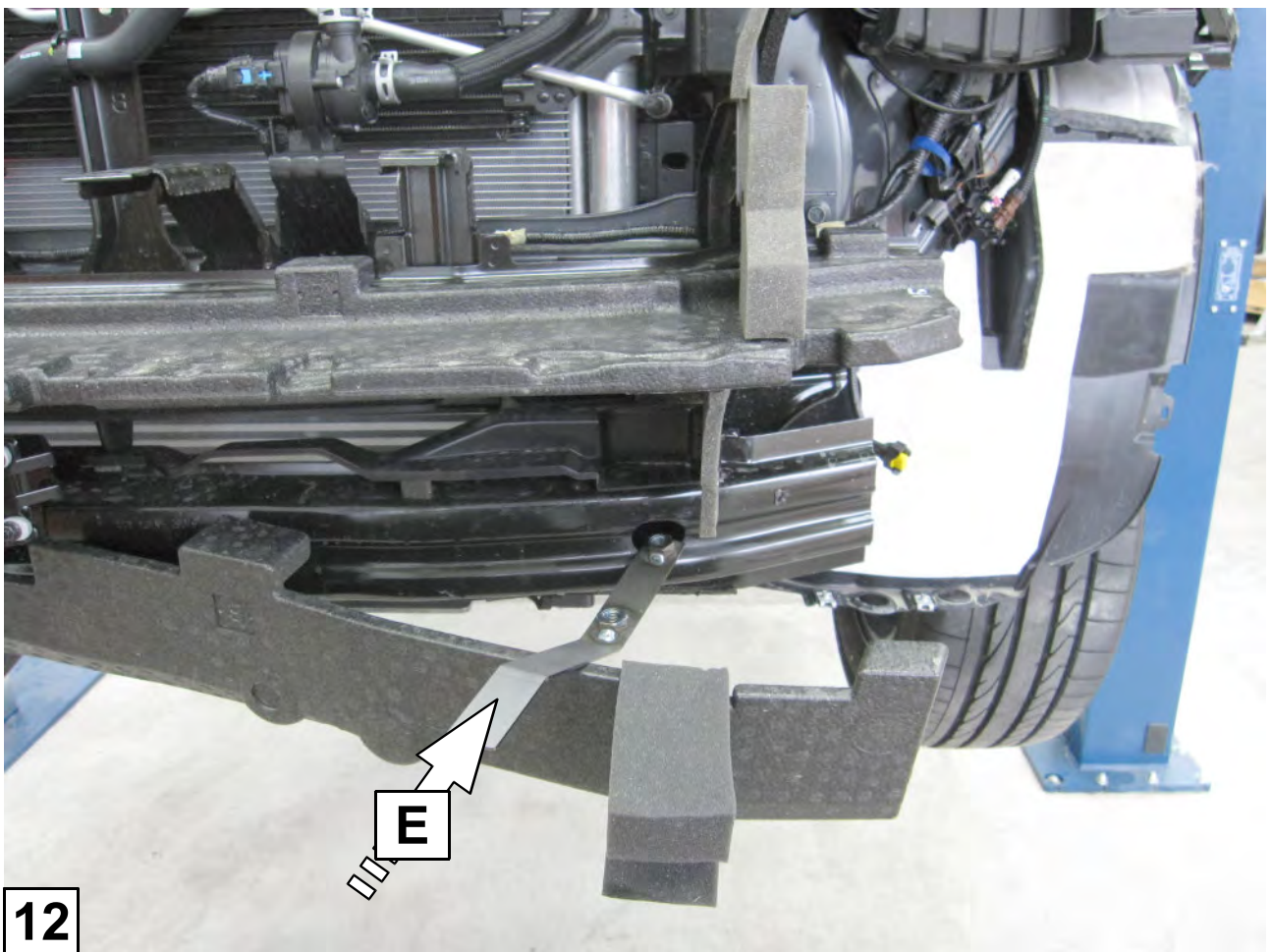
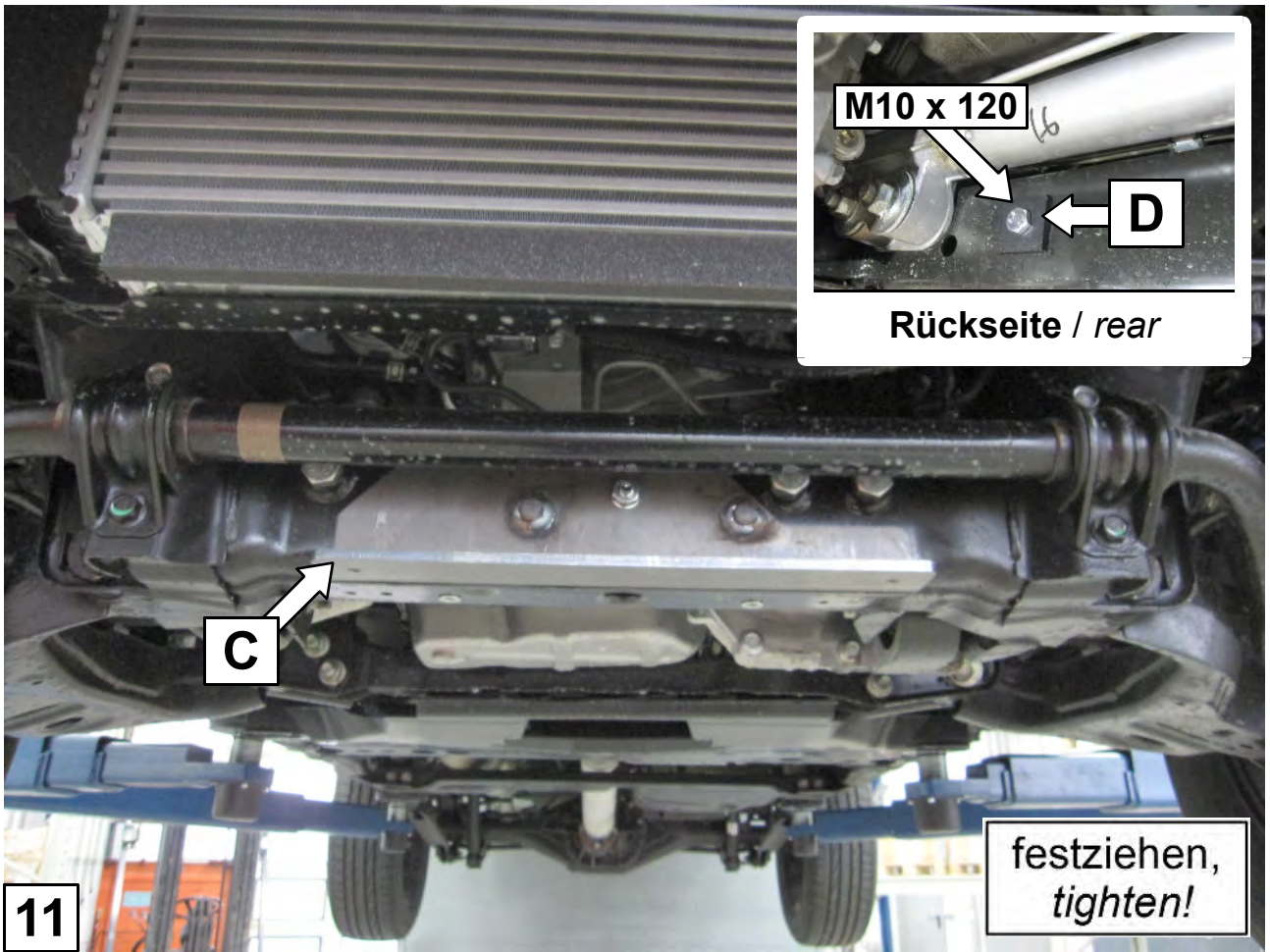



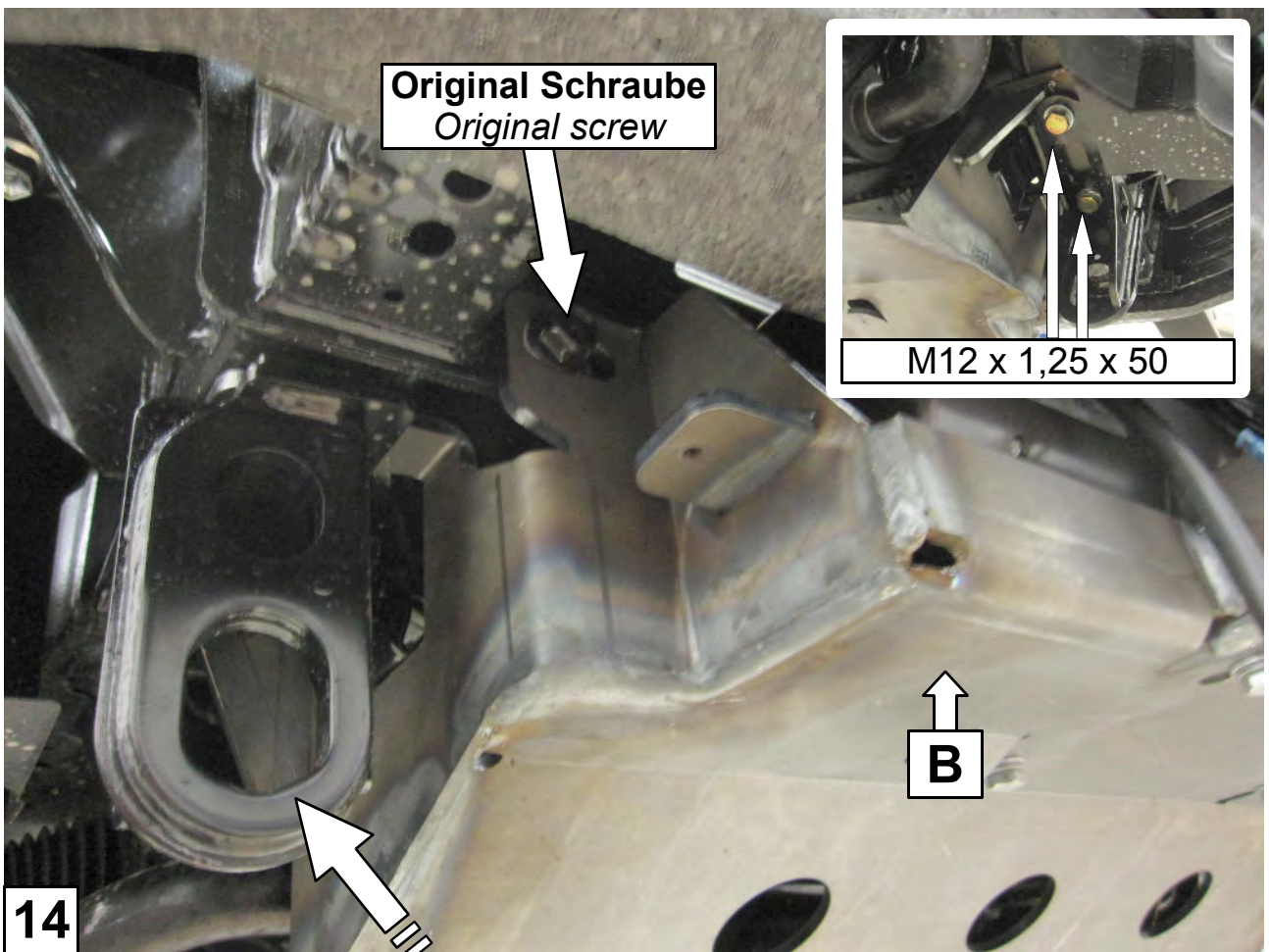
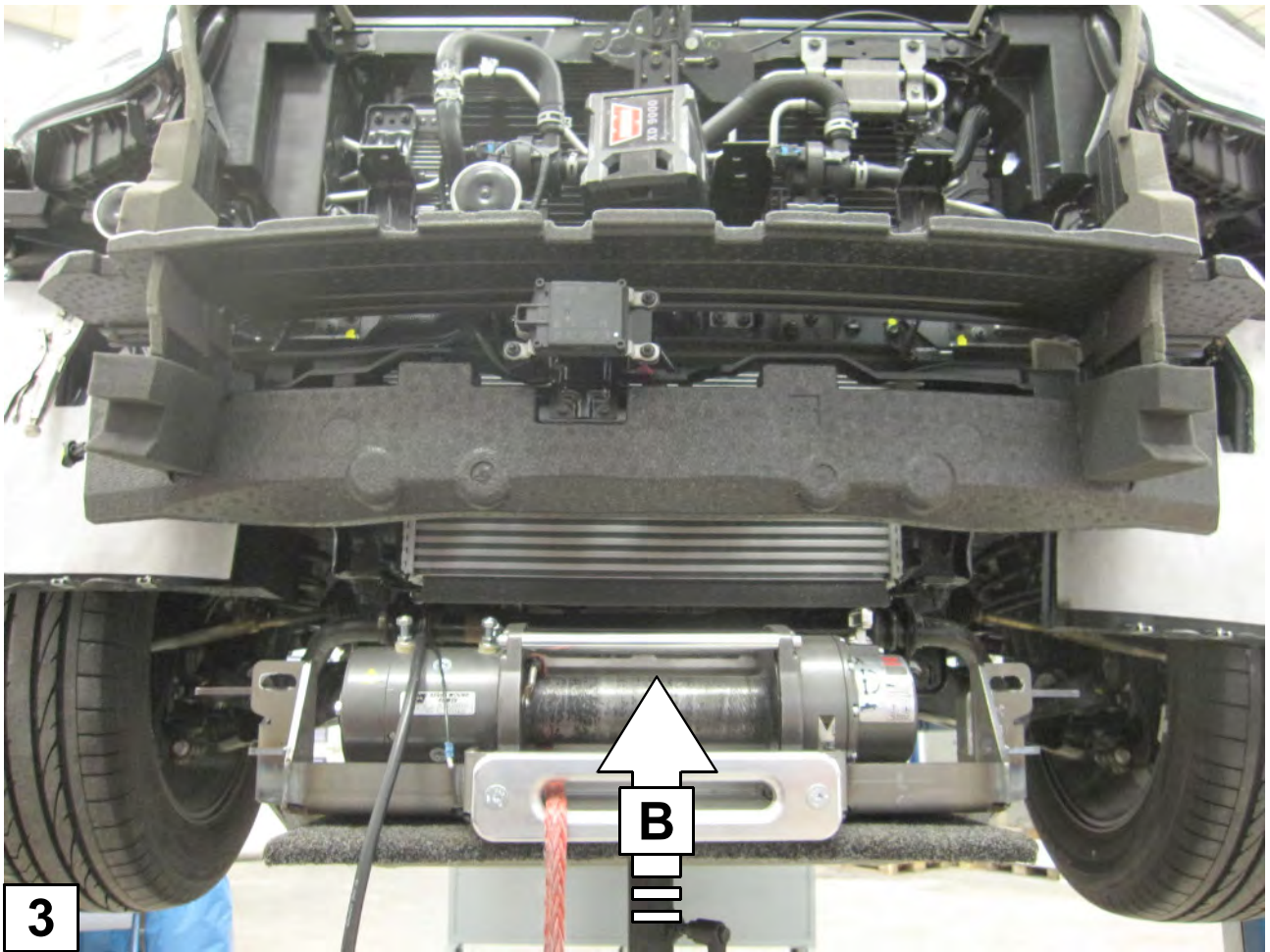



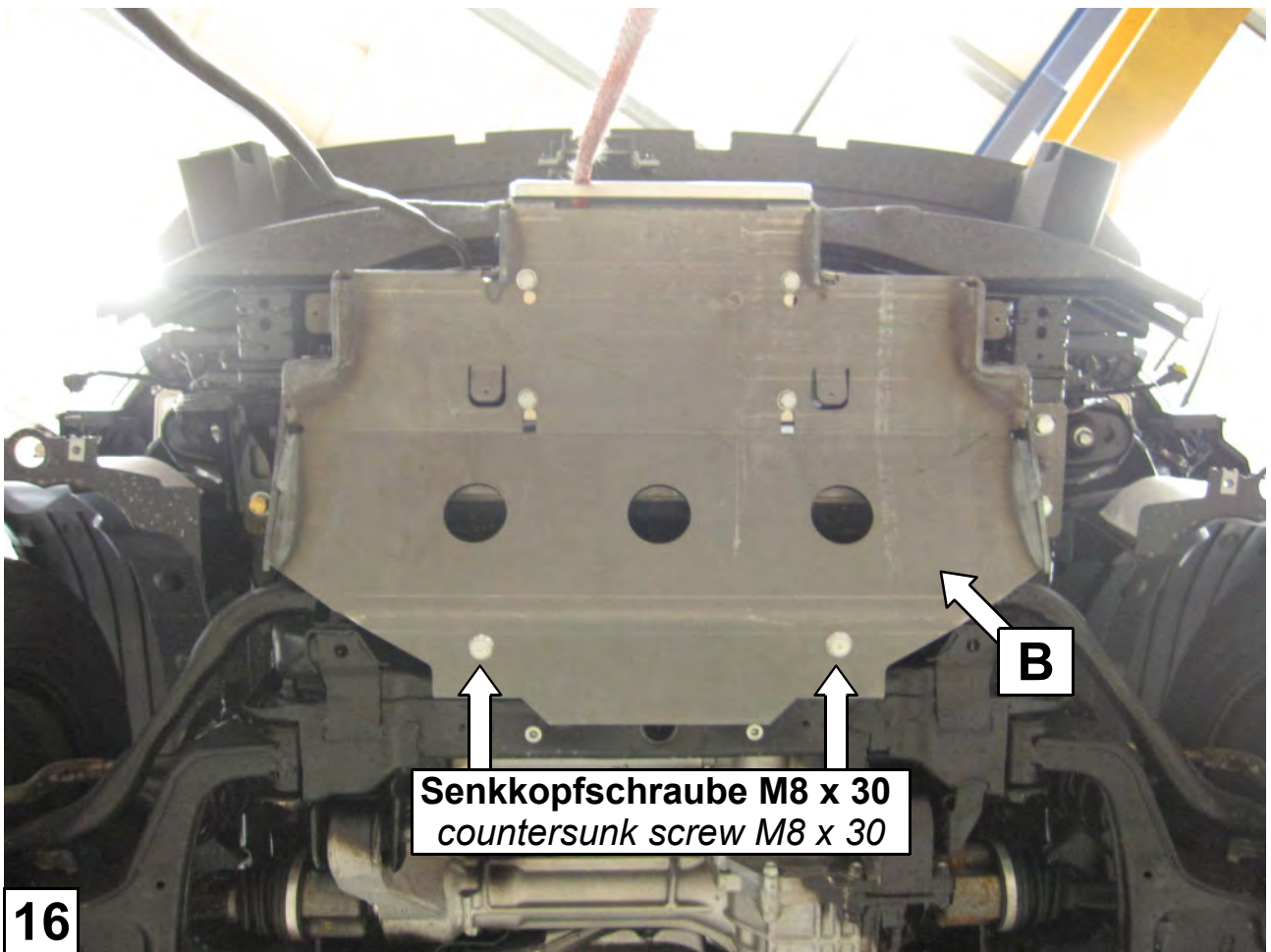
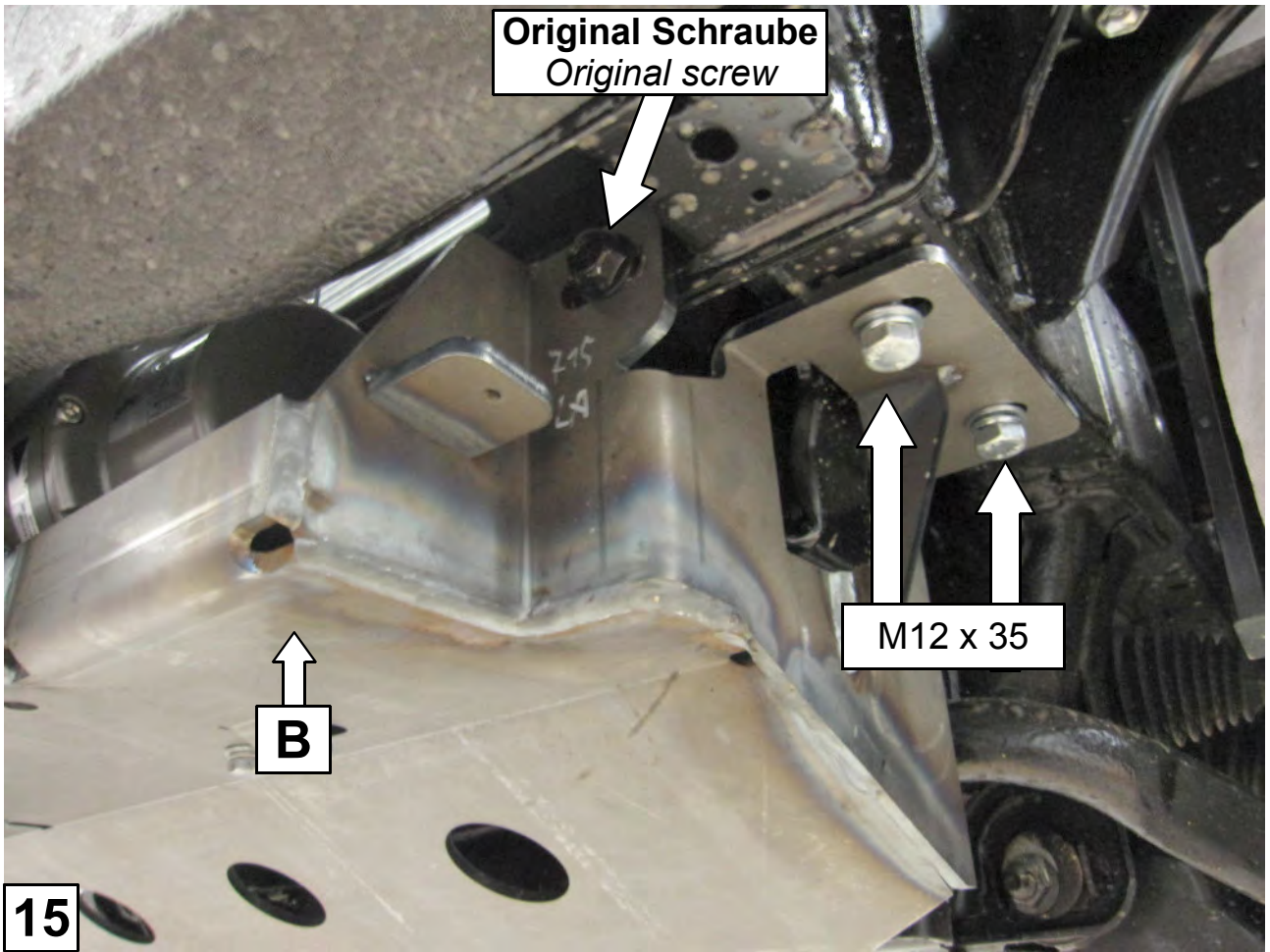



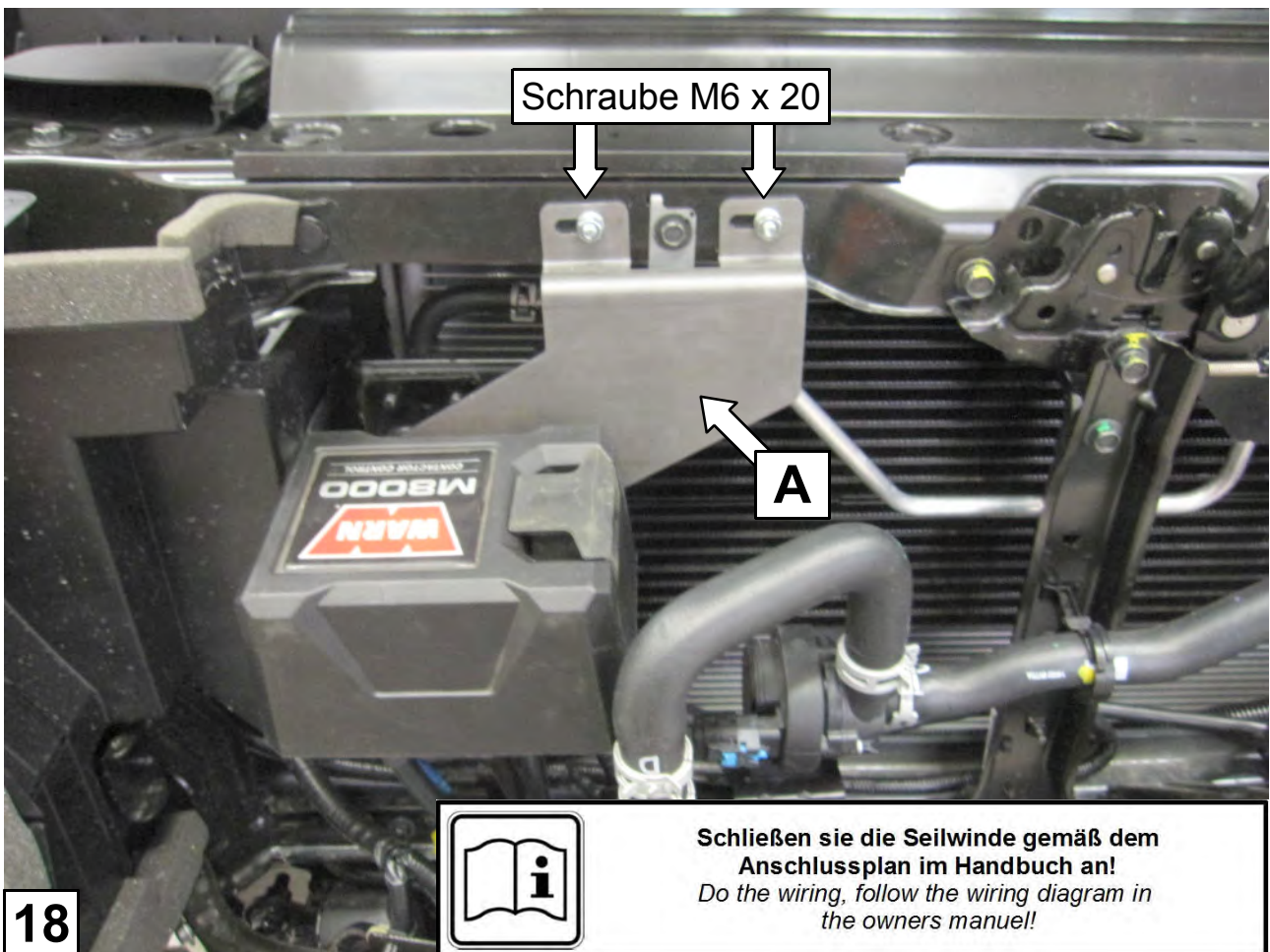
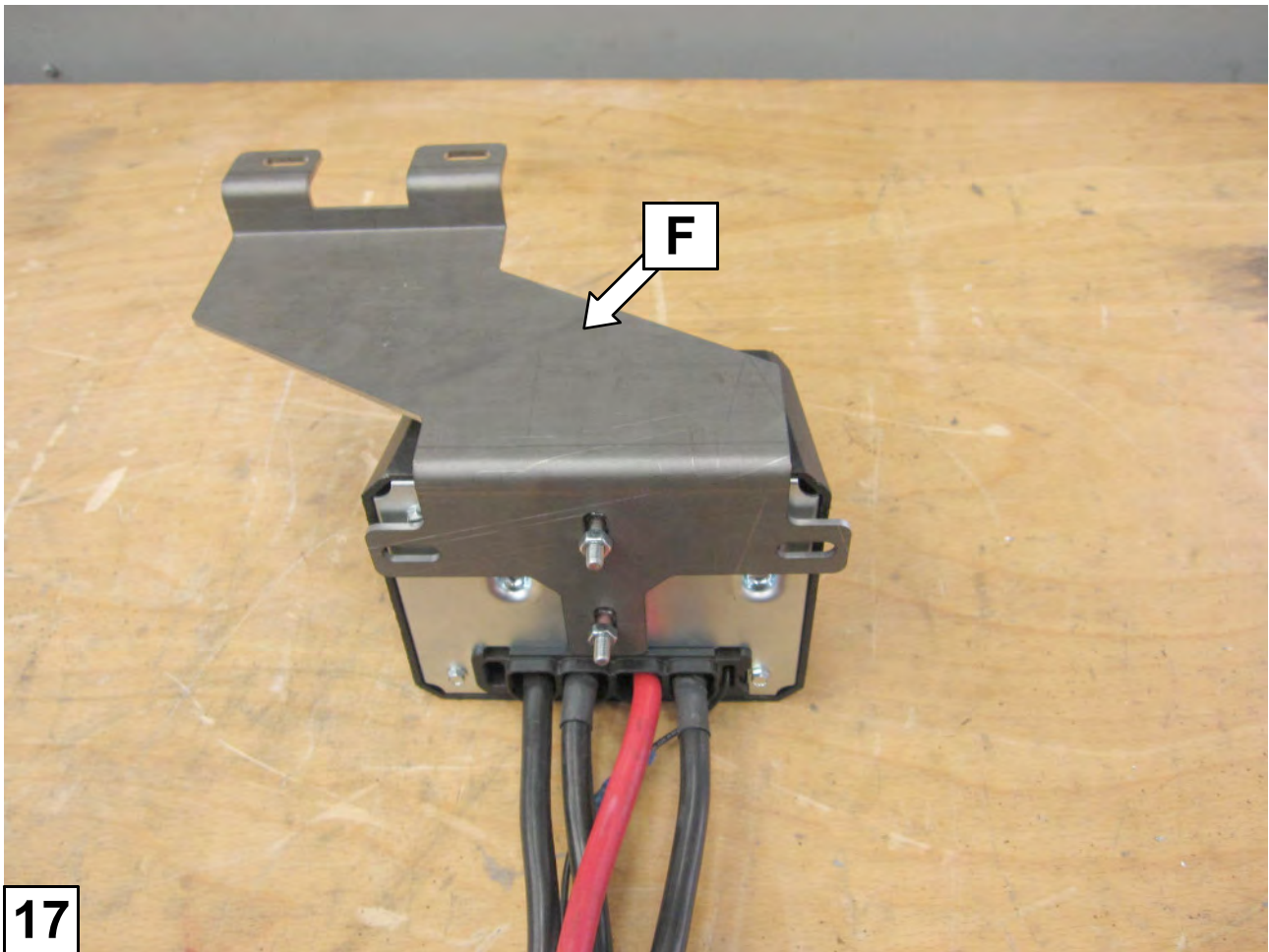



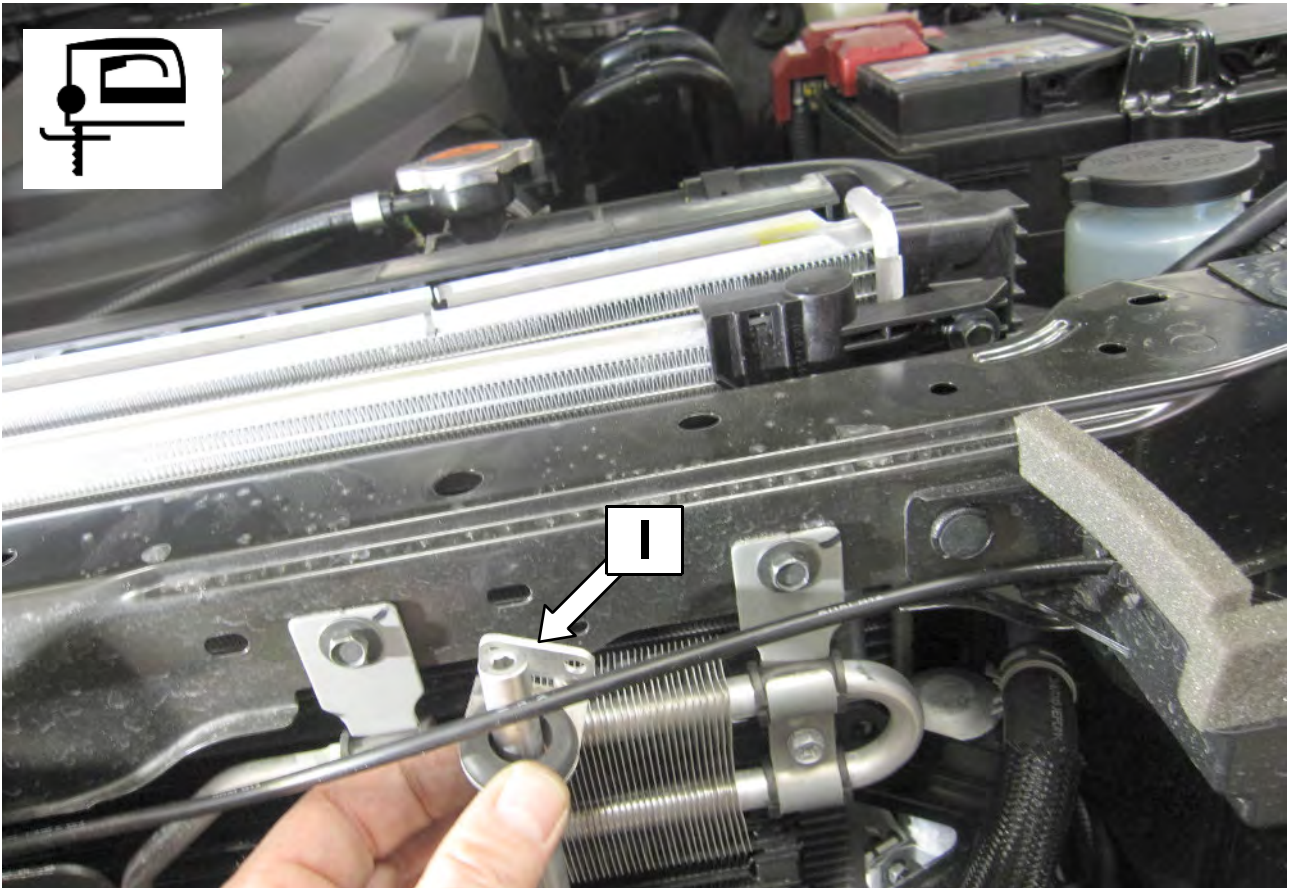

**19** Einbauanleitung 16-05070 beachten, Stange auf 550mm kürzen  
*Observe manuel 16-05070, cut the extension rod to 550mm!*

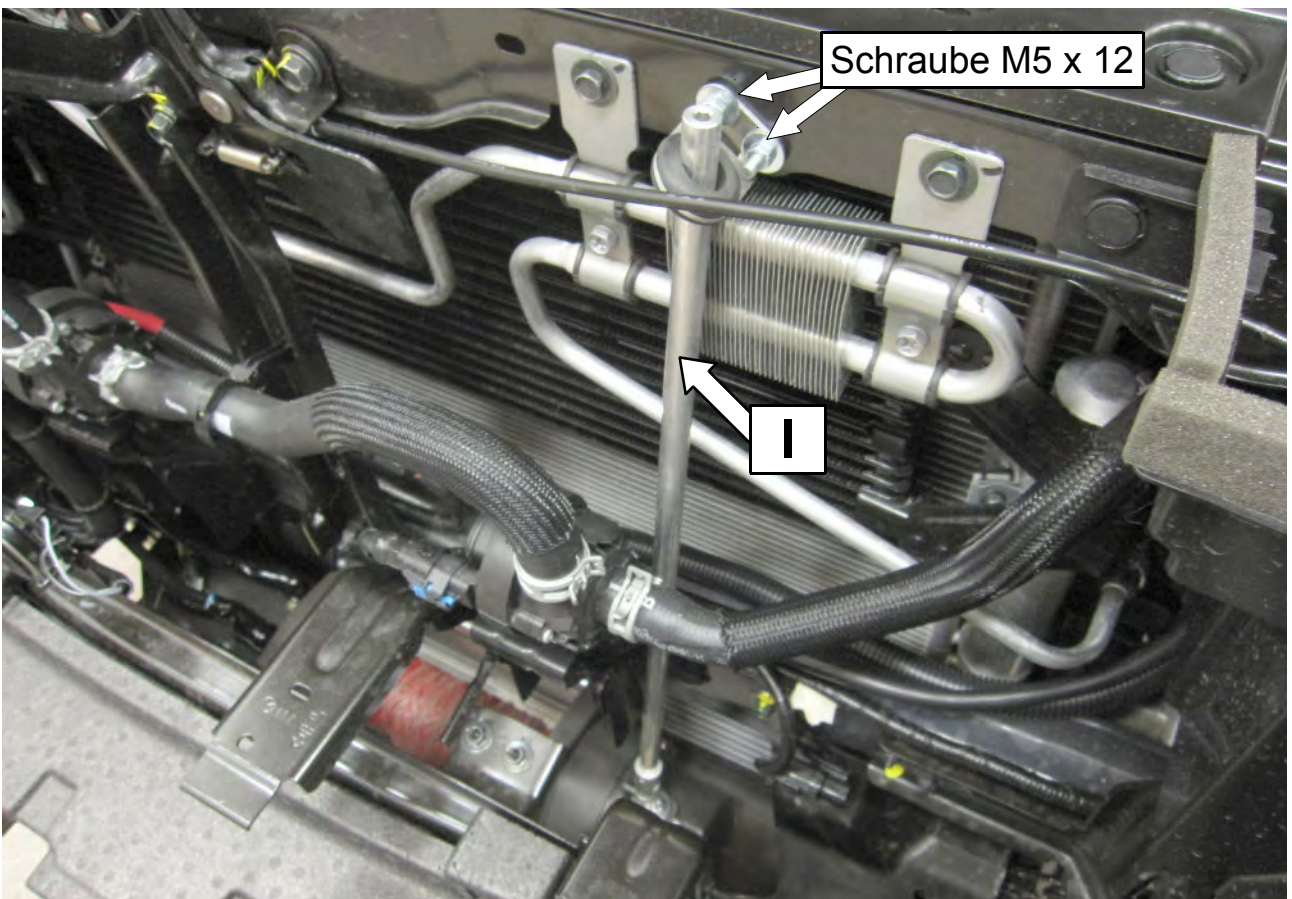

**20** Einbauanleitung 16-05070 beachten / *Observe manuel 16-05070*



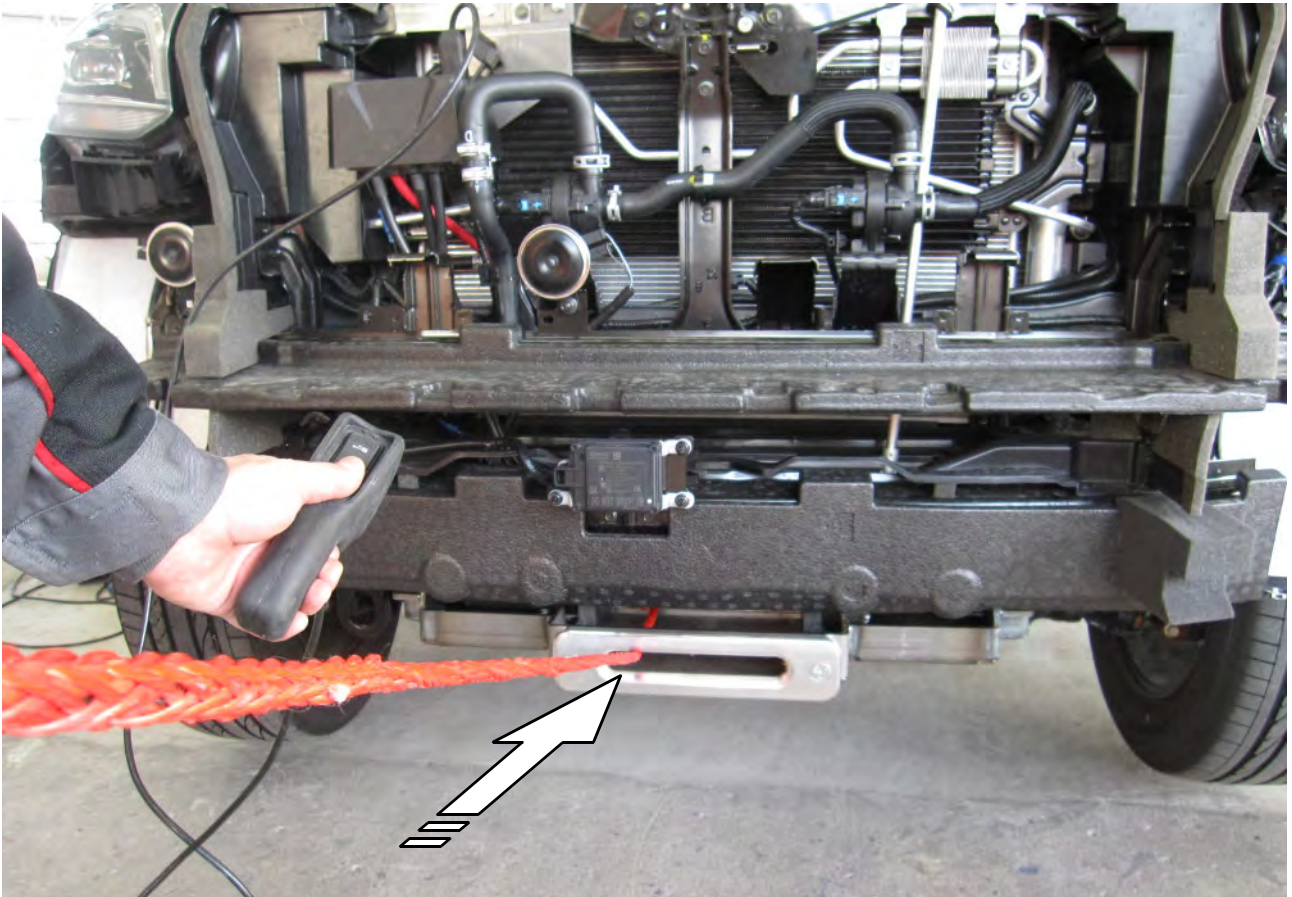

21

Seil aufspulen! / *spool in the rope!*

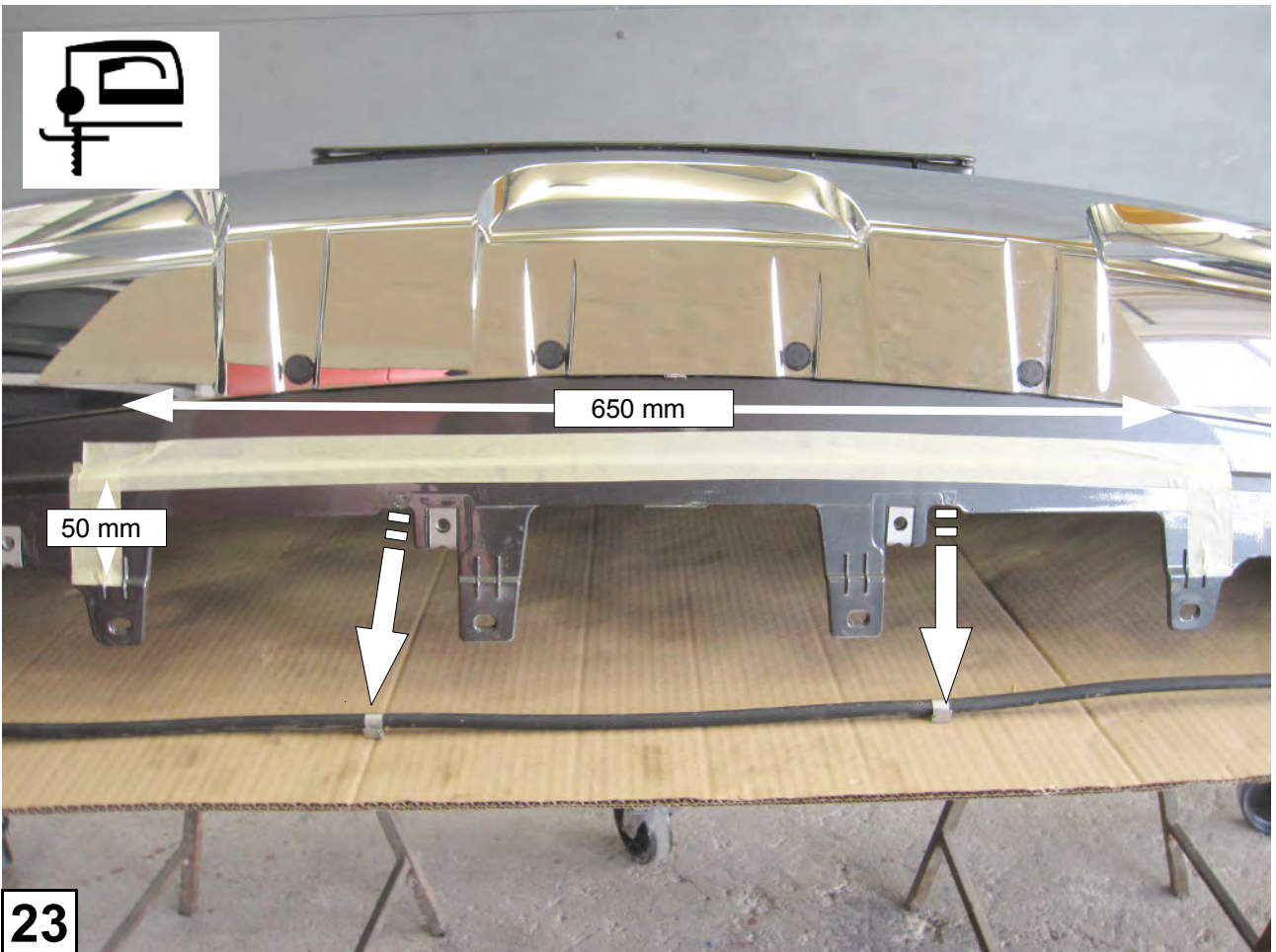

23



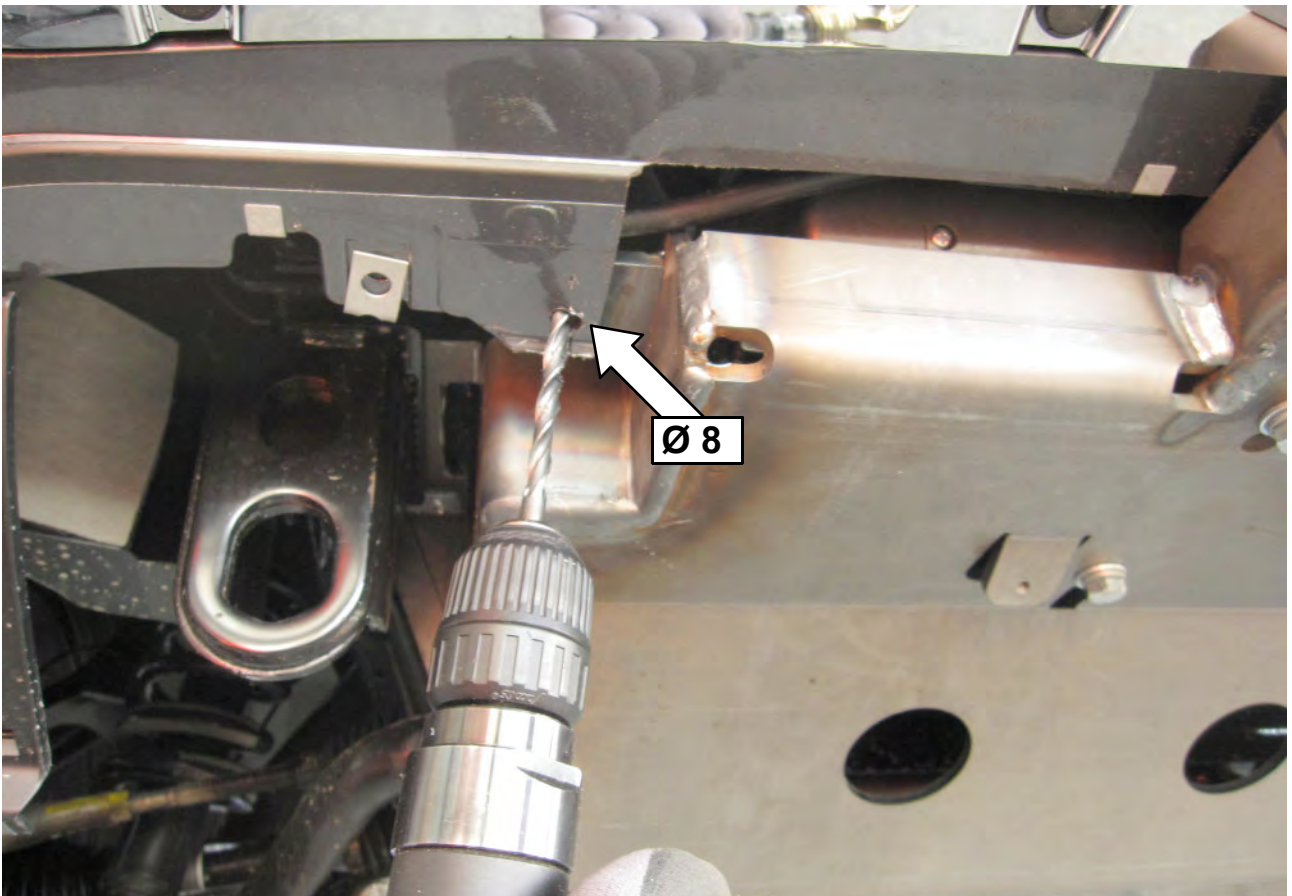

Das Gleiche an der linken Seite / the same on the left side



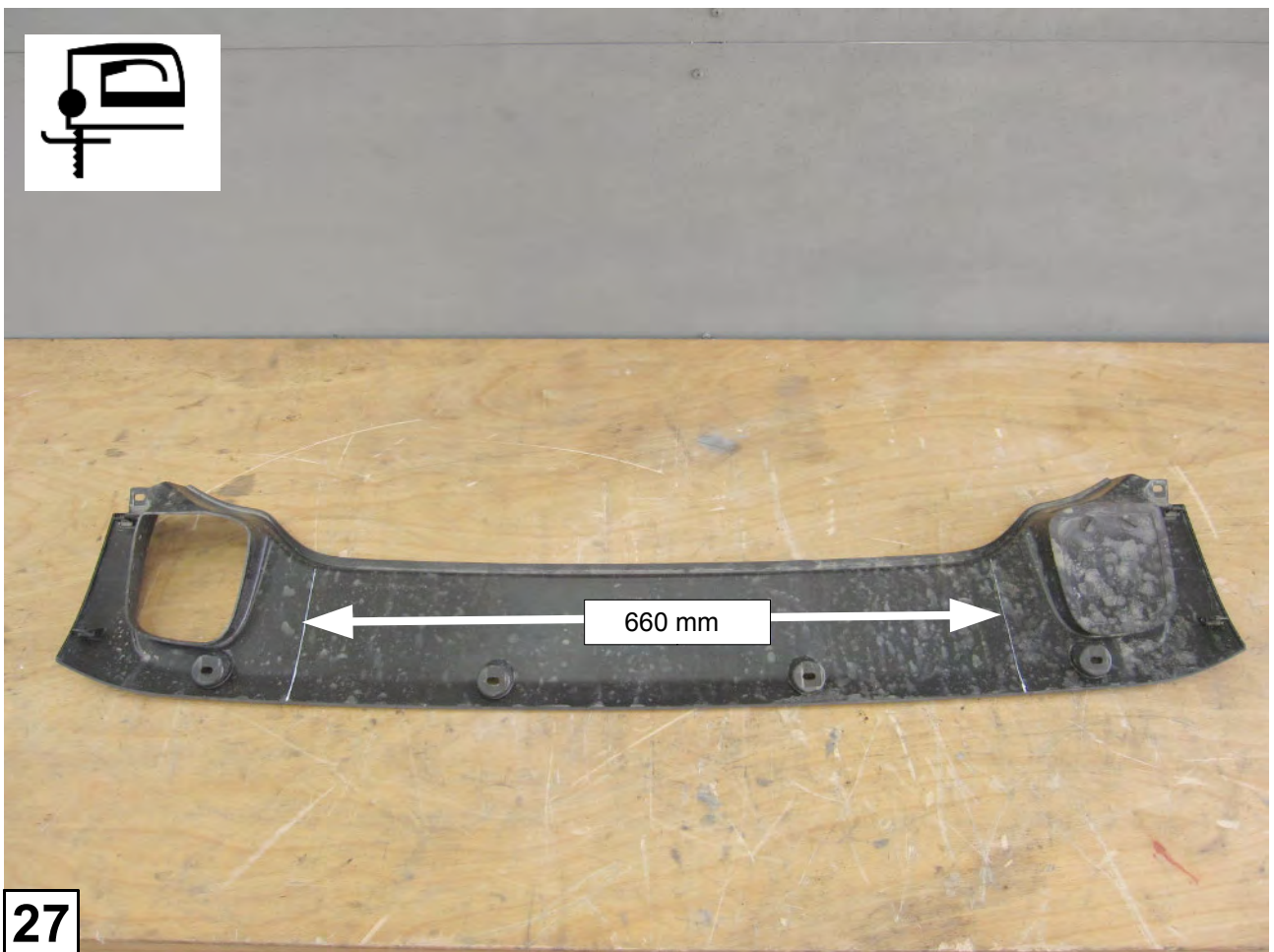
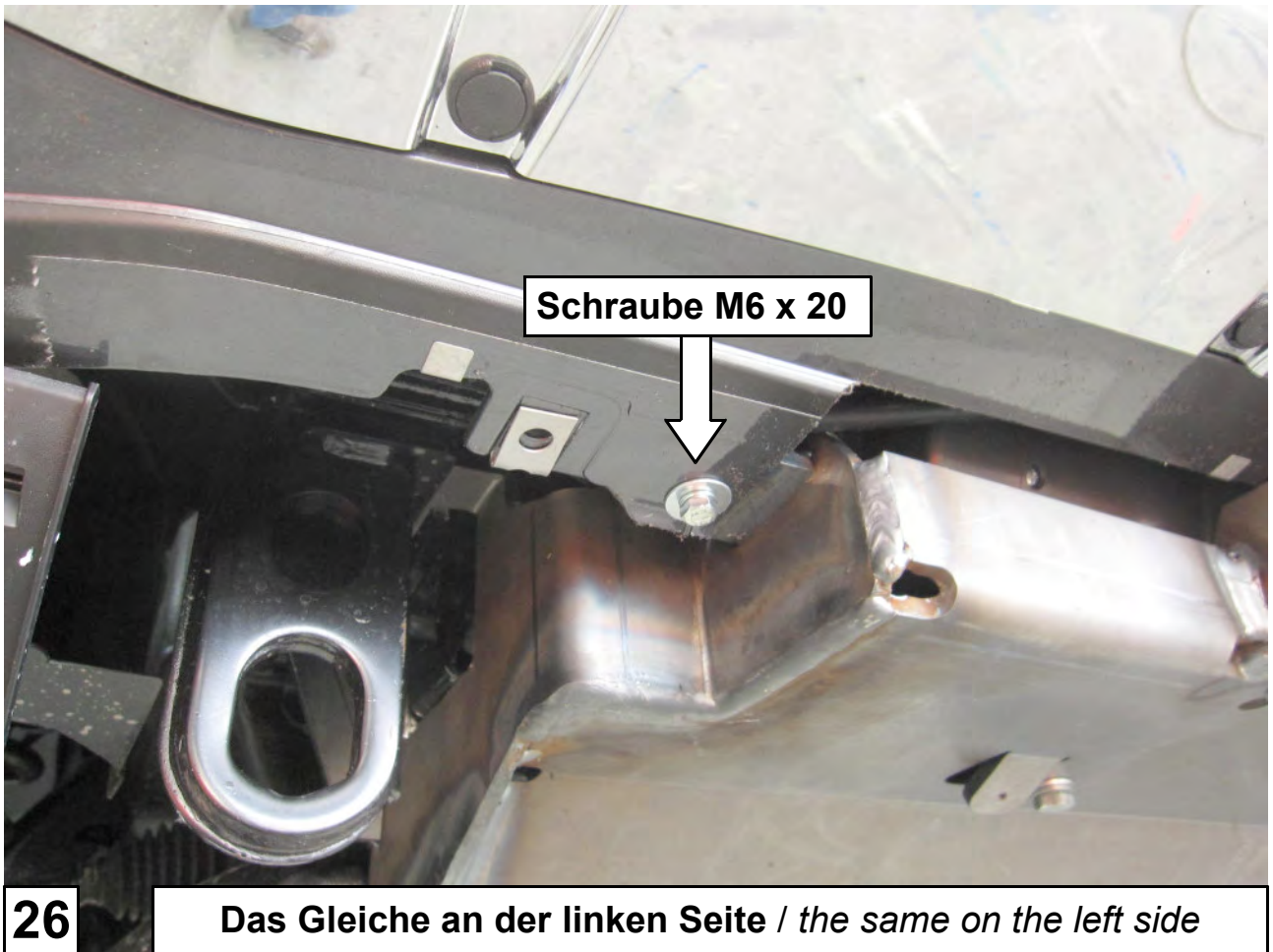



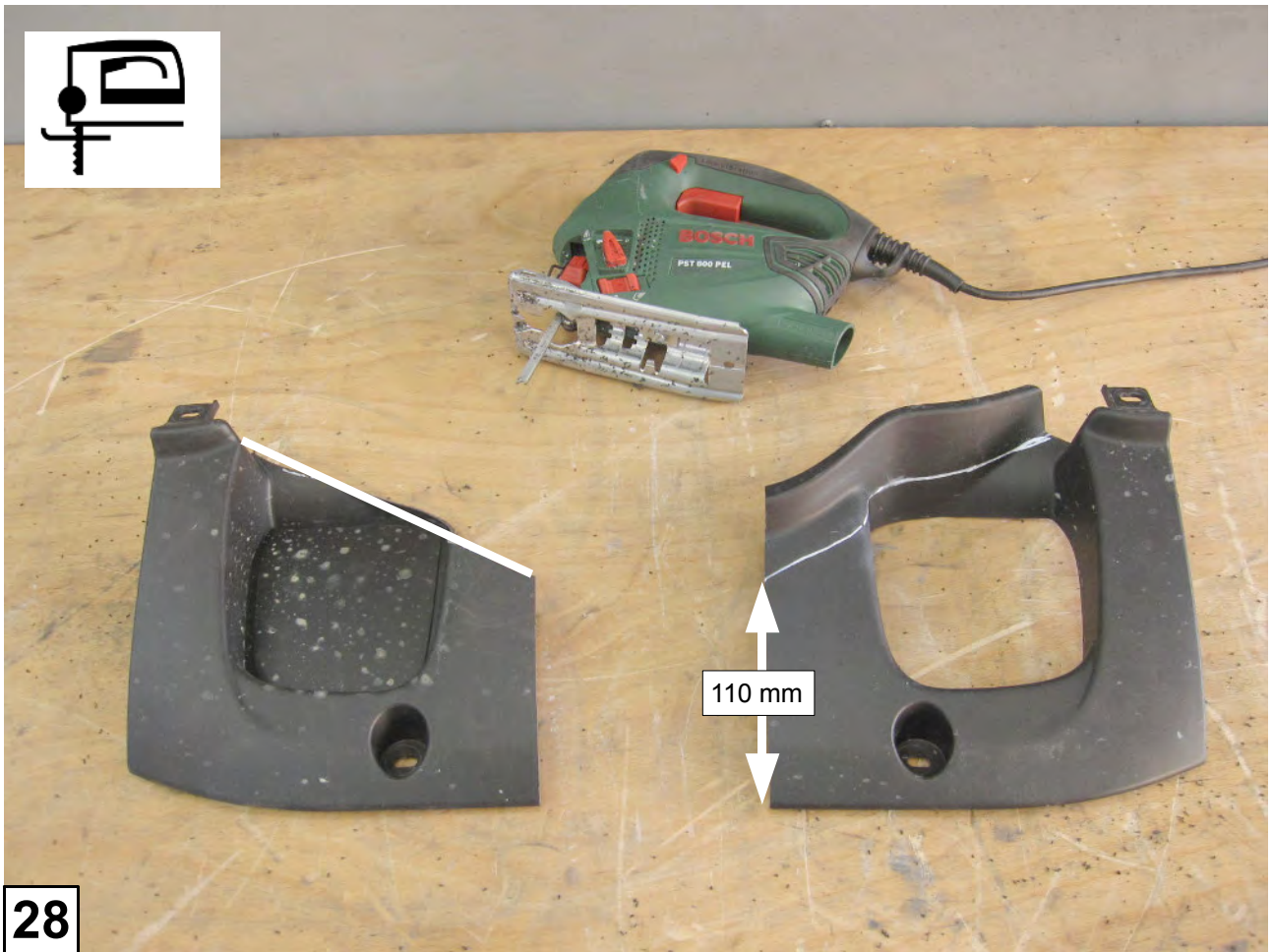

28



29



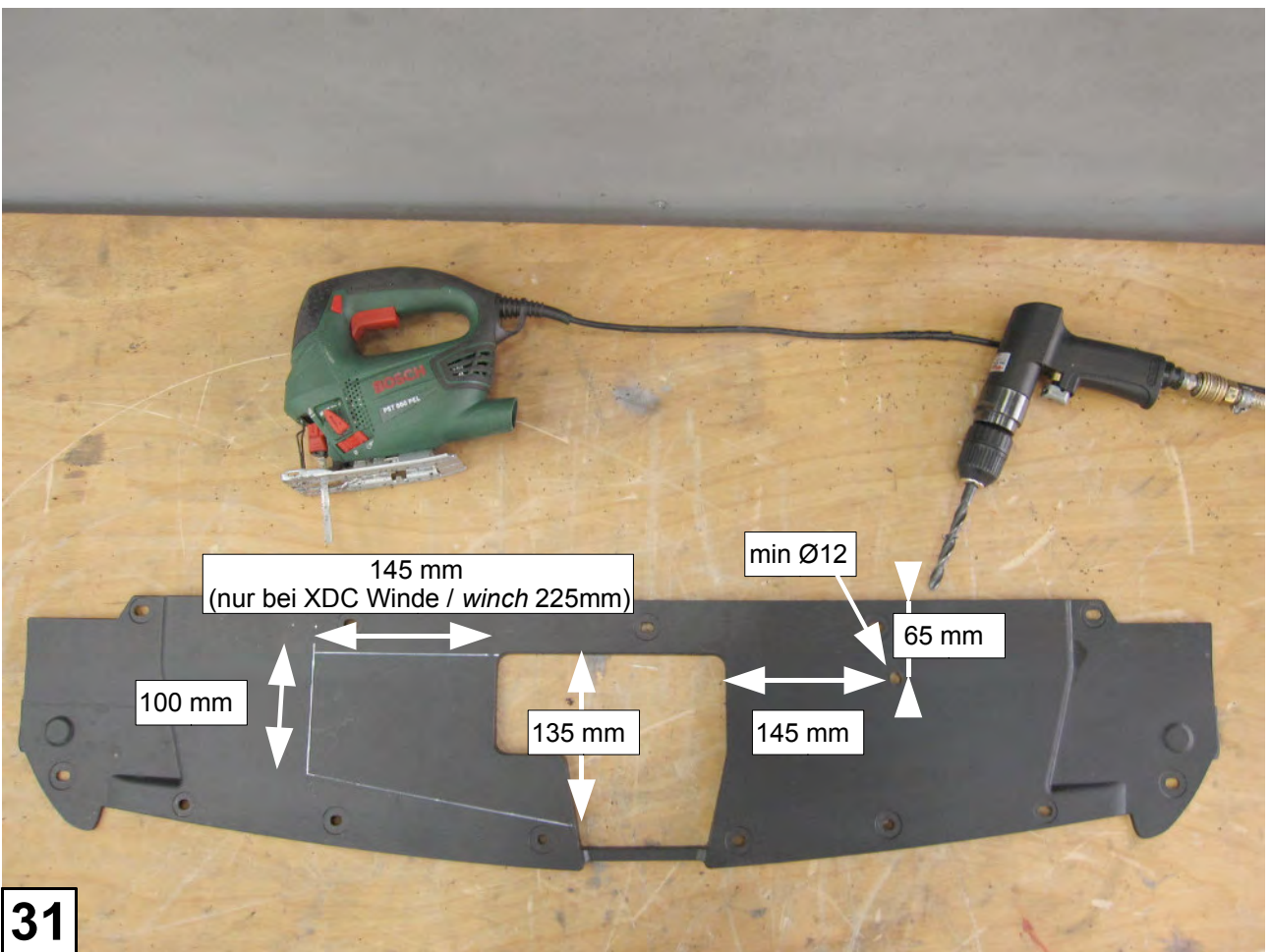



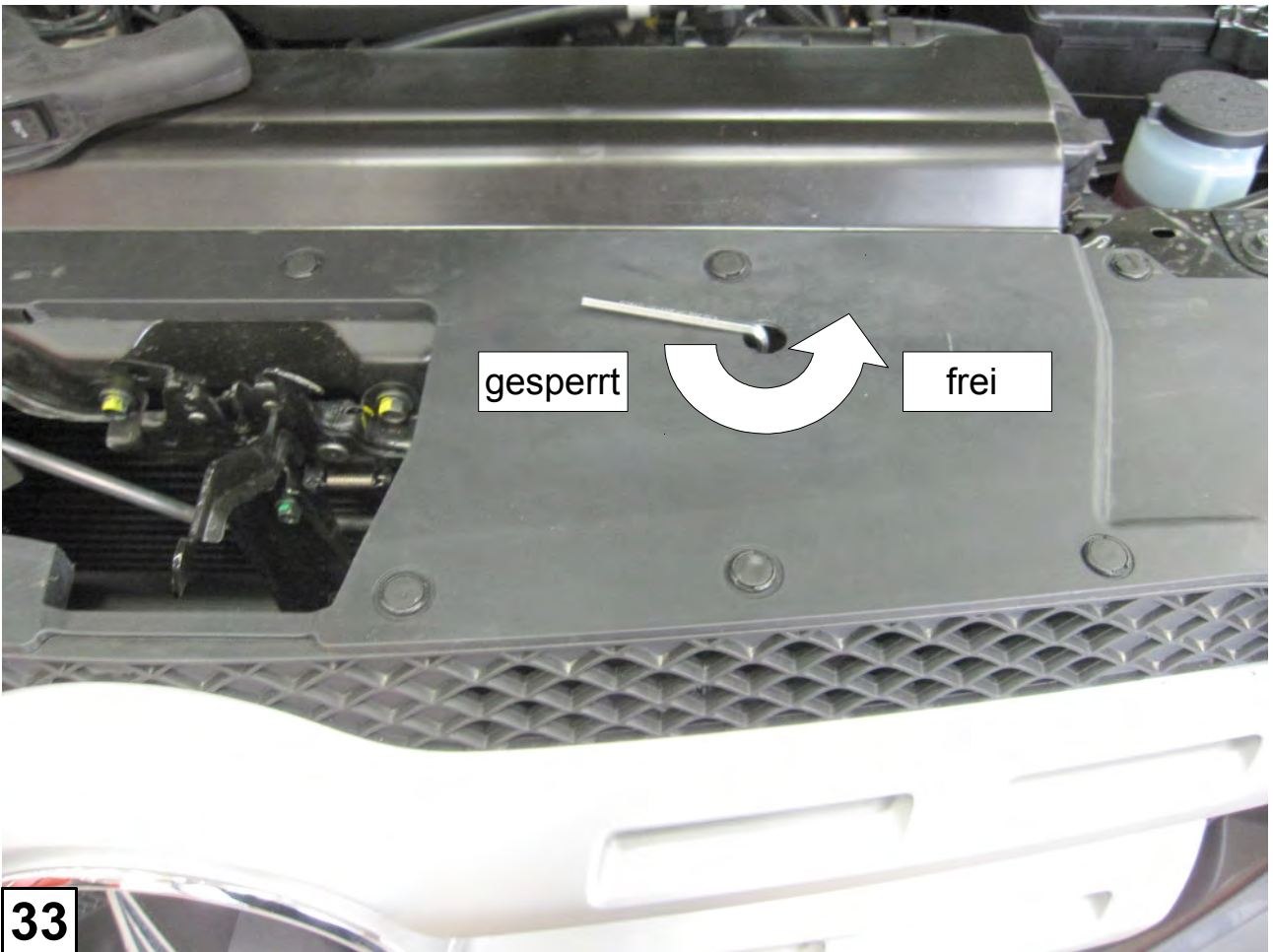
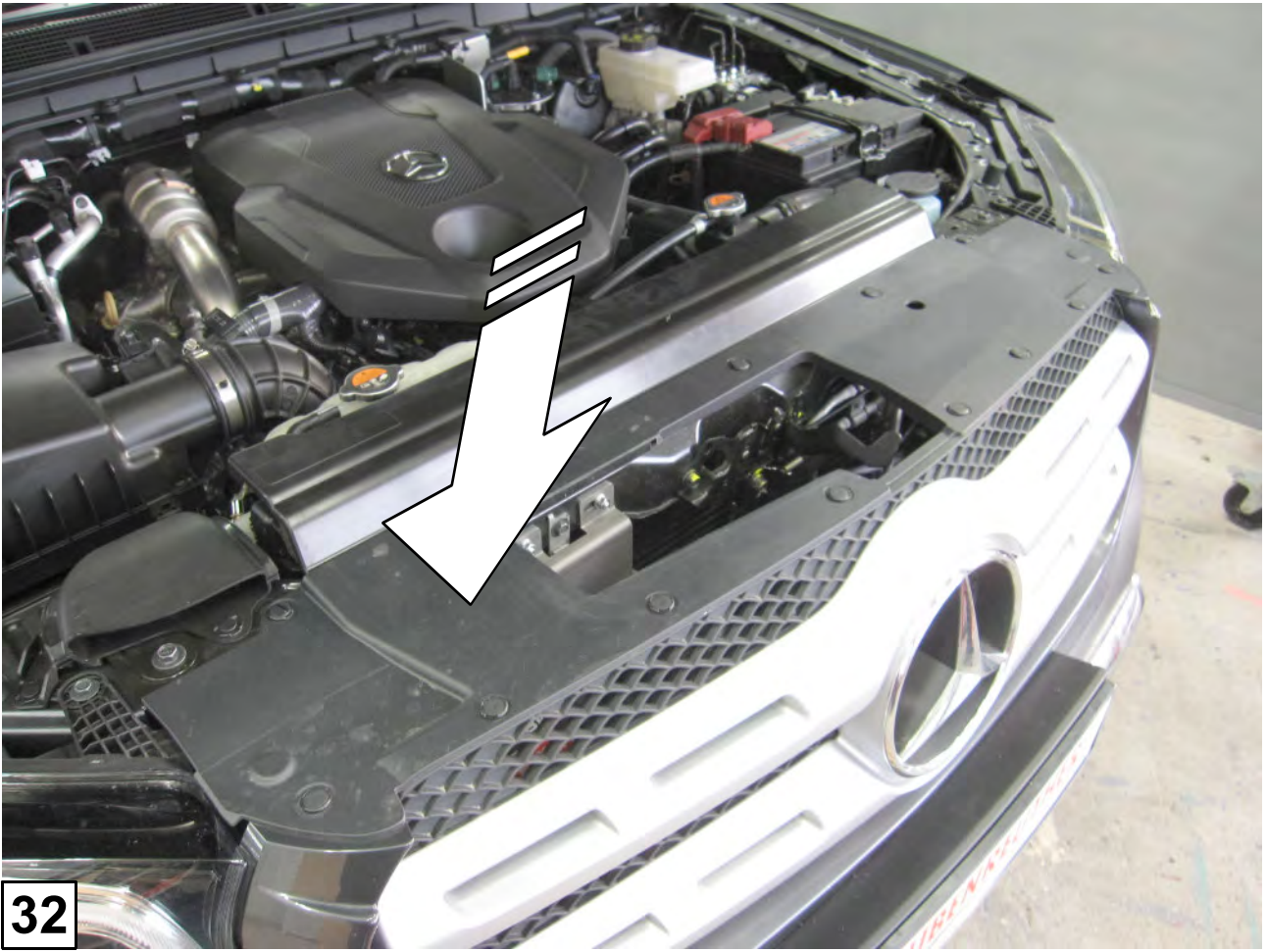



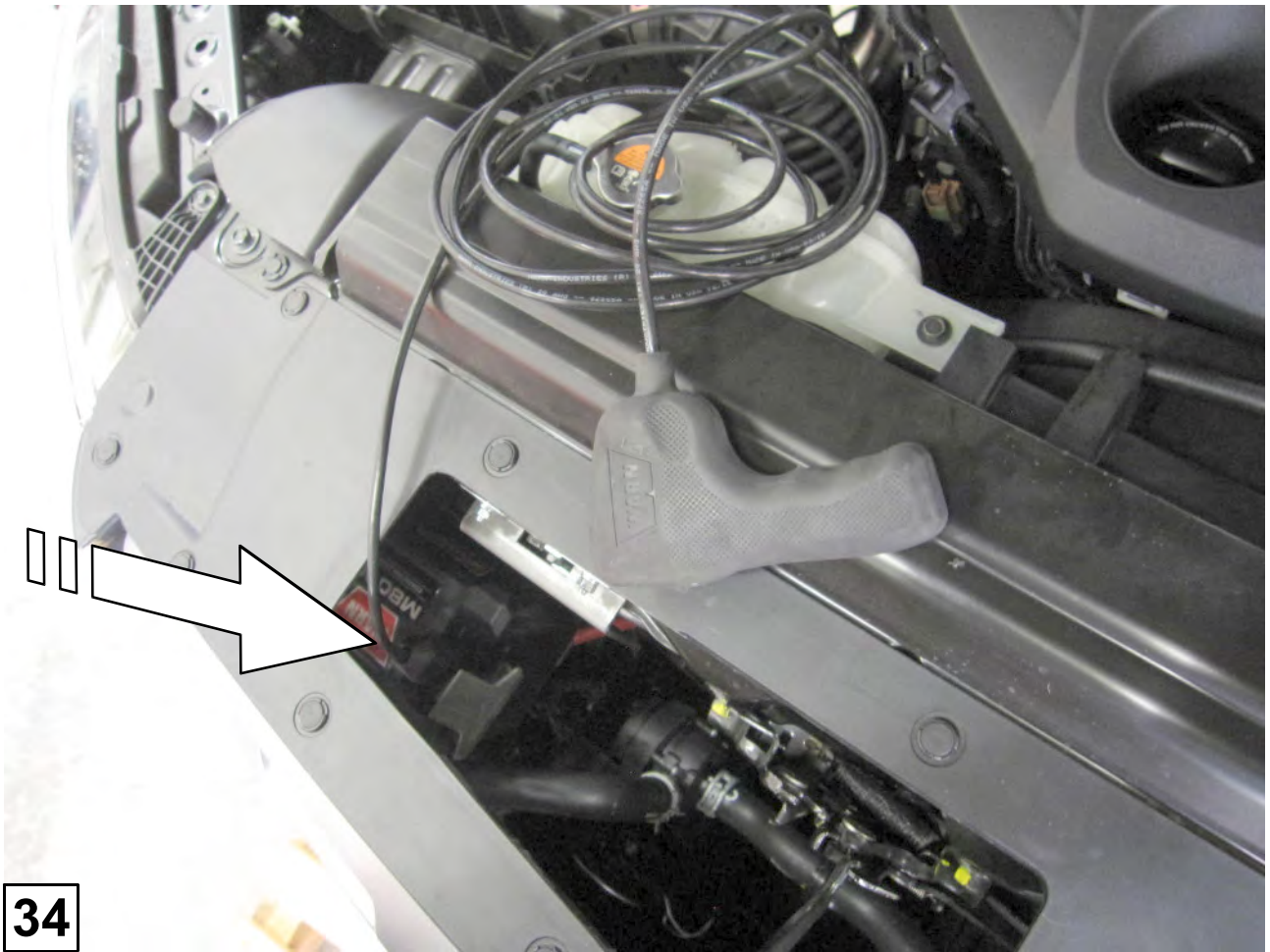

34



35



<b>Schrauben Anzugsmomente</b>	
<b>Schraubengröße</b>	<b>Güteklasse - 8.8</b>
M6	10 Nm
M8	25 Nm
M10	50 Nm
M12	87 Nm
M14	138 Nm
M16	210 Nm