

Anbauanleitung Seilwindenanbausatz VW Amarok *Installation Instruction winch mounting kit VW Amarok*

Best.-Nr.: 16 - 5380

AL: 2008 – 05



Hier sehen sie den fertig montierten Seilwindenanbausatz.
Bevor sie mit der Montage beginnen, lesen sie bitte diese Anleitung
und das Benutzerhandbuch der Seilwinde gut durch.

Achtung:

Bei Fahrten im öffentlichen Straßenverkehr muß das Rollenseilfenster mit
der Kunststoffabdeckung Best.nr.: **15 – 899** abgedeckt werden.

Stückliste Seilwindenanbausatz VW Amarok

Partlist winch mounting kit VW Amarok

Best.nr.: 16 - 5380

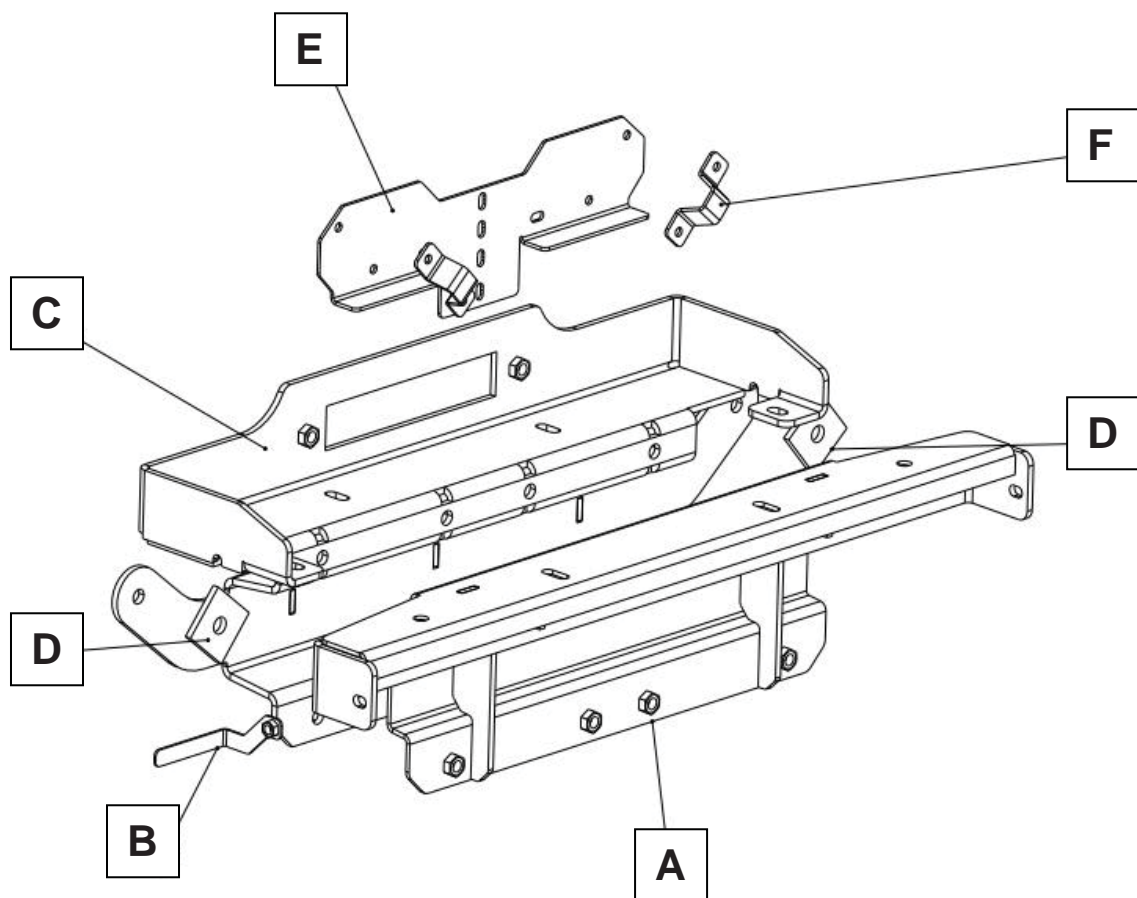

1 x Seilwindenträger hinten (A)

1 x Halter mit Mutter (B)

1 x Seilwindenträger vorne (C)

2 x Distanzplatte (D)

1 x Schaltkastenhalter (E)

2 x Schelle (F)

1 x Kunststoffabdeckung 15 – 899

1 x Anbauanleitung AL 2008

1 x Gutachten

2 x Schraube M 12 x 40
4 x U-Scheibe M 12 x 40 x 3
2 x Federring M 12
2 x Mutter M 12

10 x Schraube M 10 x 30
2 x Schraube M 10 x 25
14 x U-Scheibe M 10 x 30 x 2
12 x Federring M 10

2 x Schraube M 8 x 30
2 x U – Scheibe M 8
4 x U-Scheibe M8 x 25 x 2
2 x Federring M 8

2 x Schraube M 6 x 20
4 x Schraube M 6 x 30
8 x U-Scheibe M 6
4 x U – Scheibe M6 x 15 x 1,5
6 x Federring M 6
6 x Mutter M 6

Achtung: Wenn sie eine **ZEON** Winde verbauen möchten, empfehlen wir dringend die Verwendung der Steckdosenverlängerung 1- 90394 !

Attention: If you want to fit a **ZEON** winch, we recommend to use the socket extension kit 1-90394 !

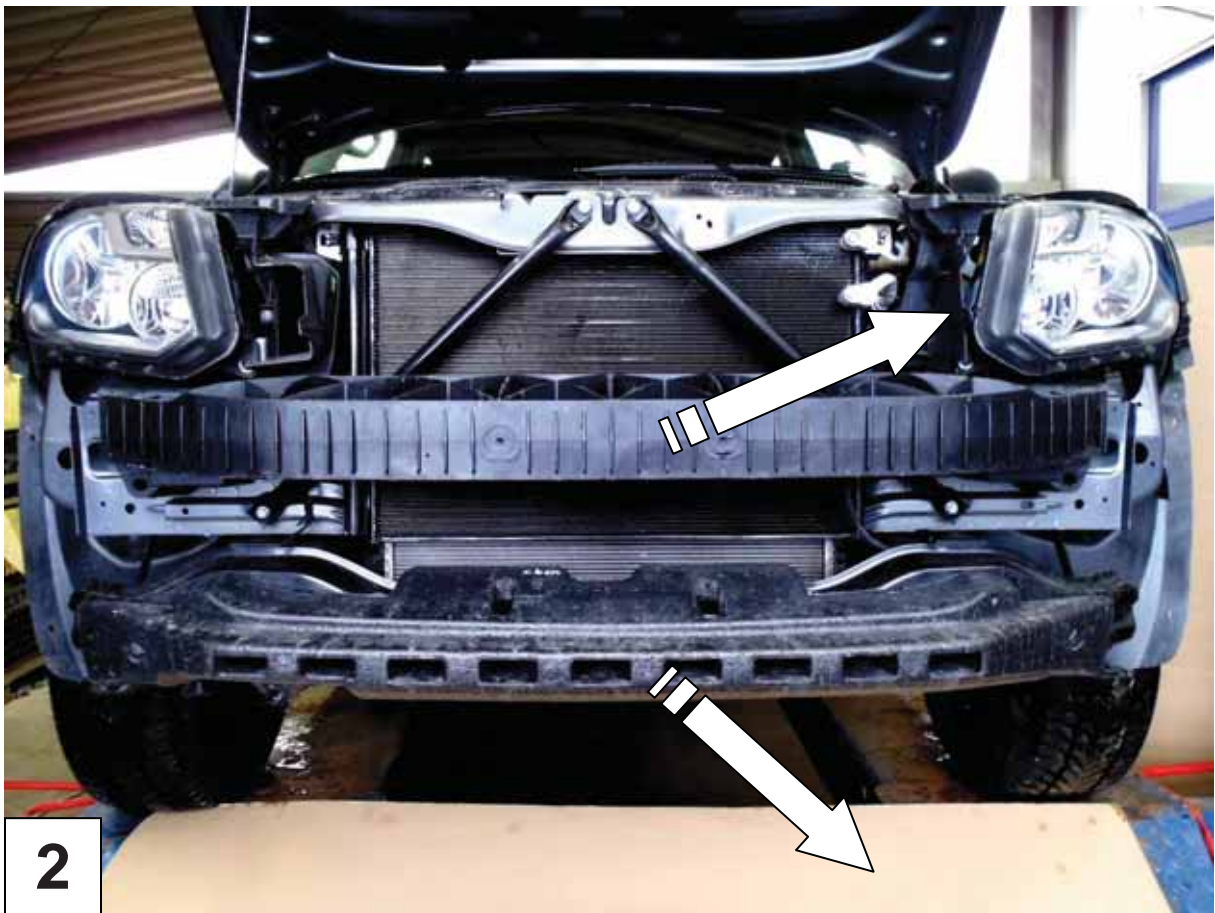



3

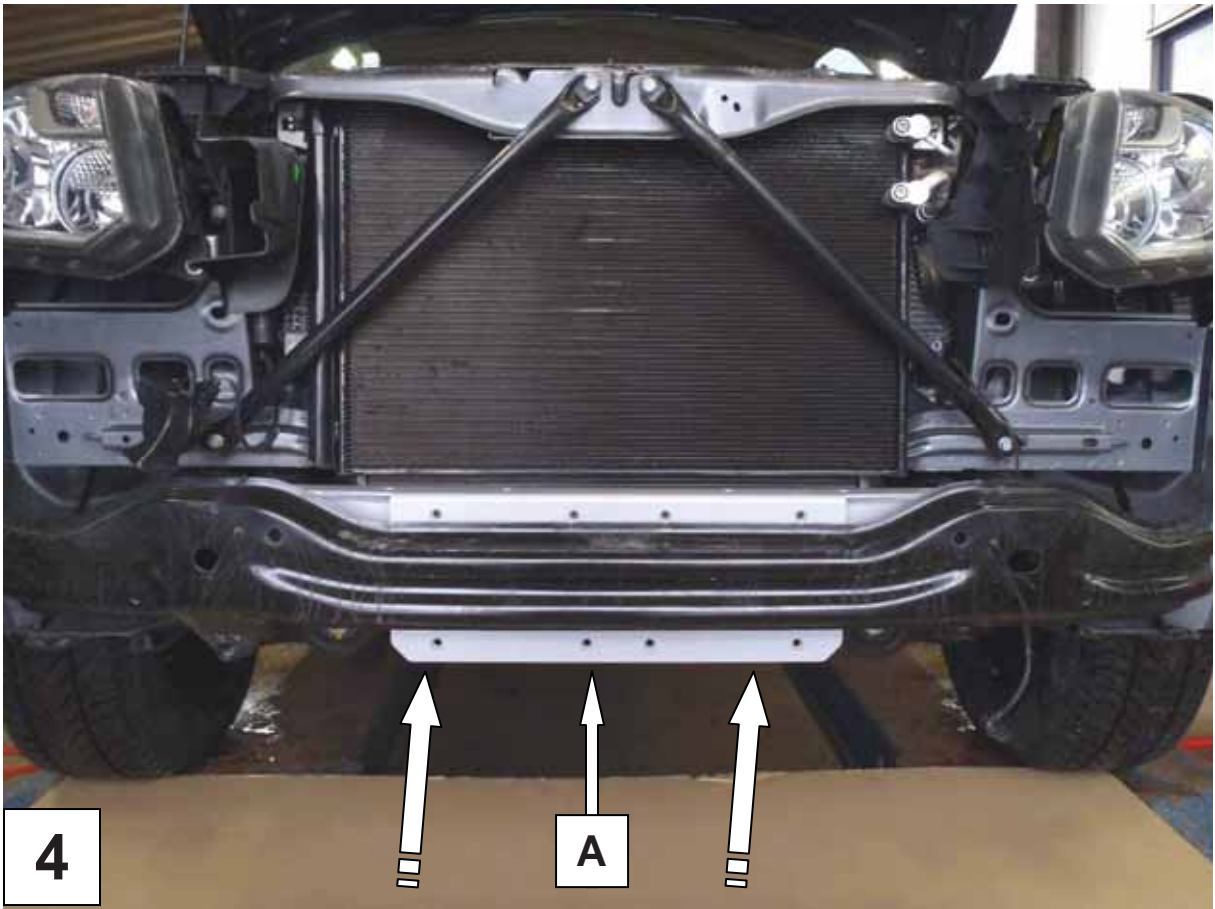

4

A

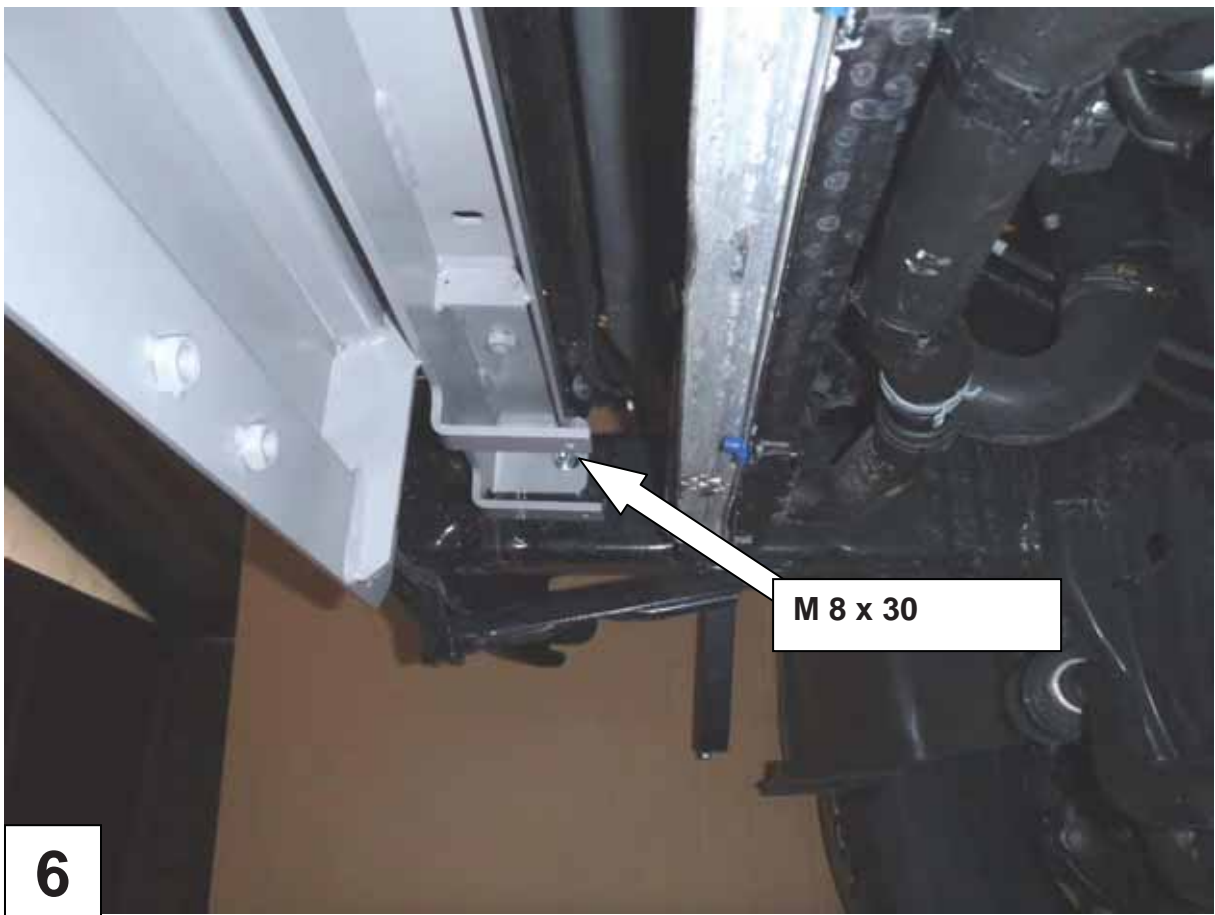
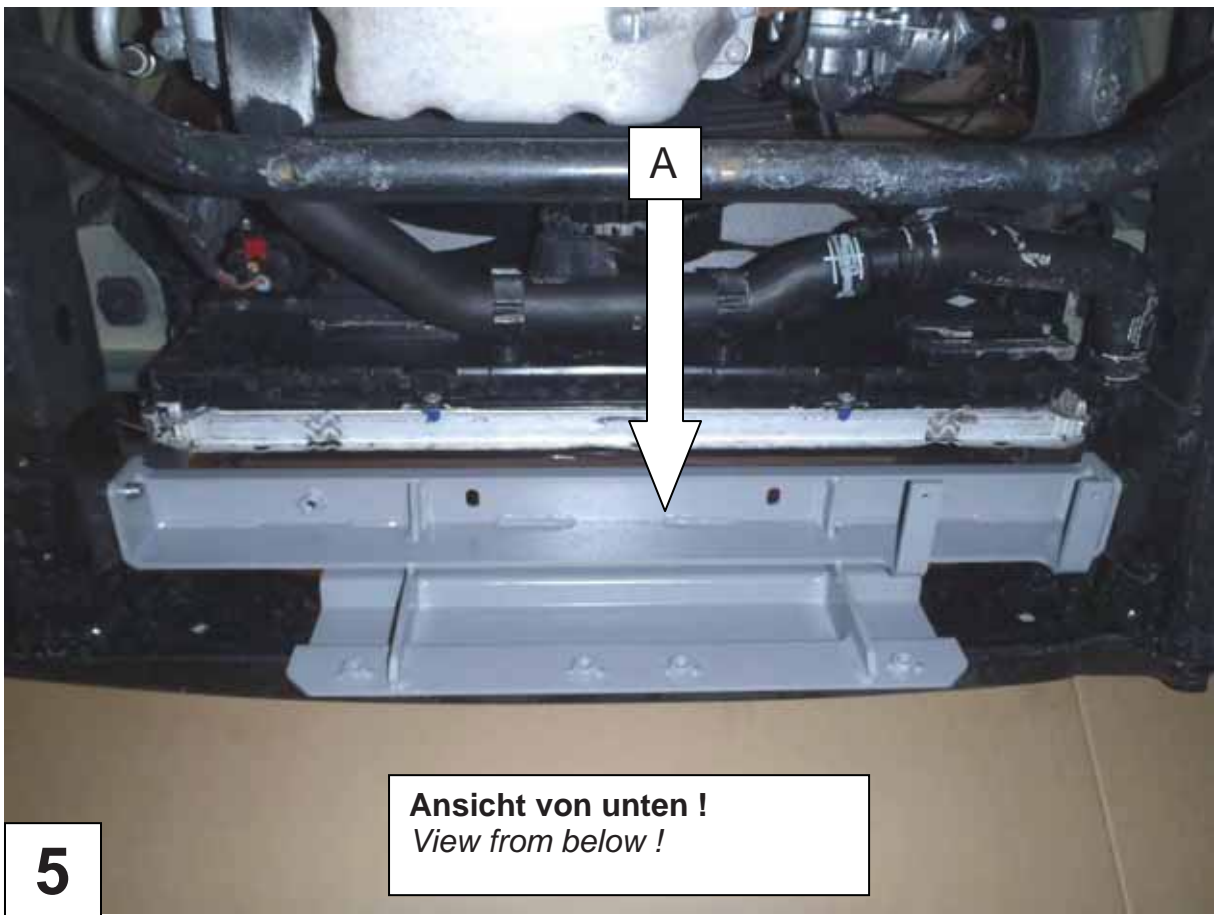

Toleranzen sollten mit den U-Scheiben 8 x 25 x 2 ausgeglichen werden!
Tolerances should get balanced with the shims 8 x 25 x 2!

M 8 x 30

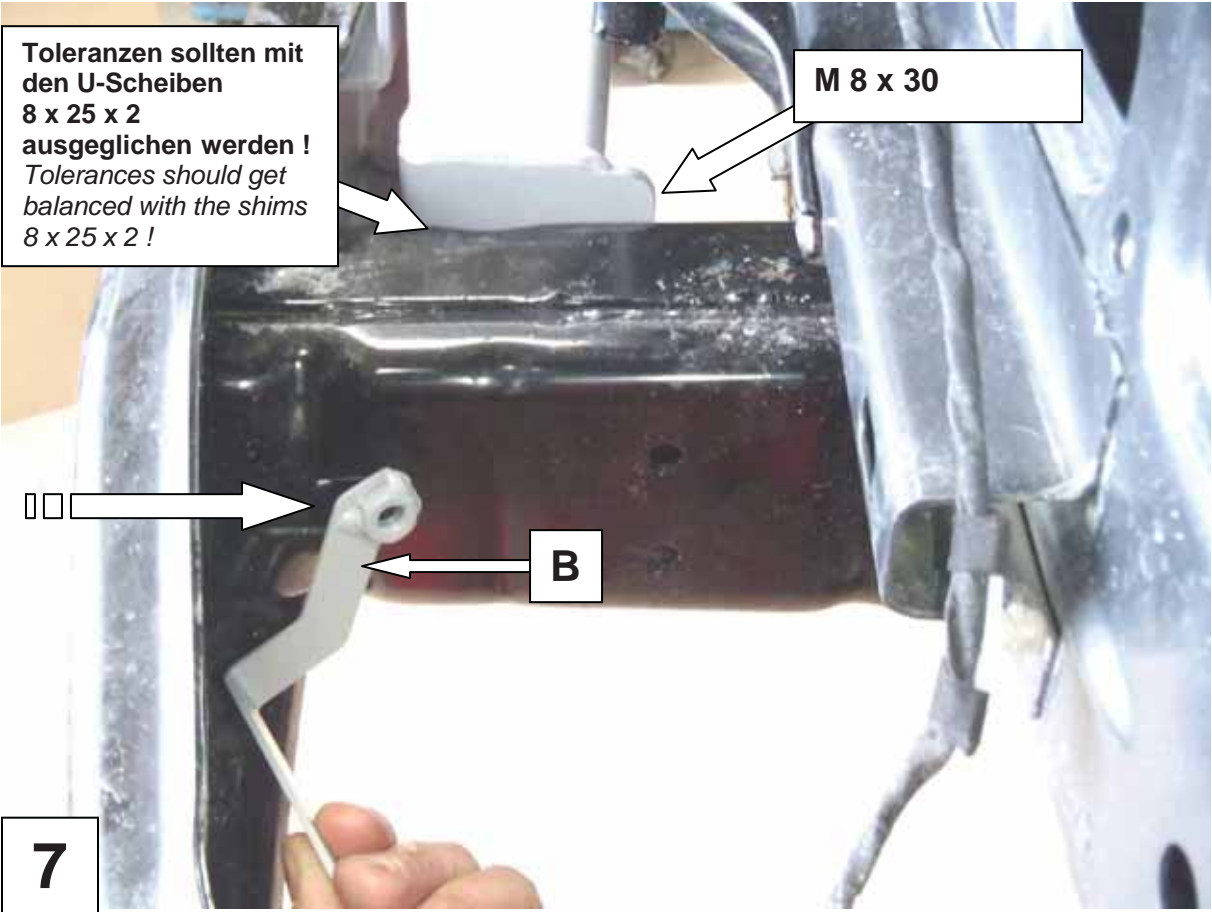

7

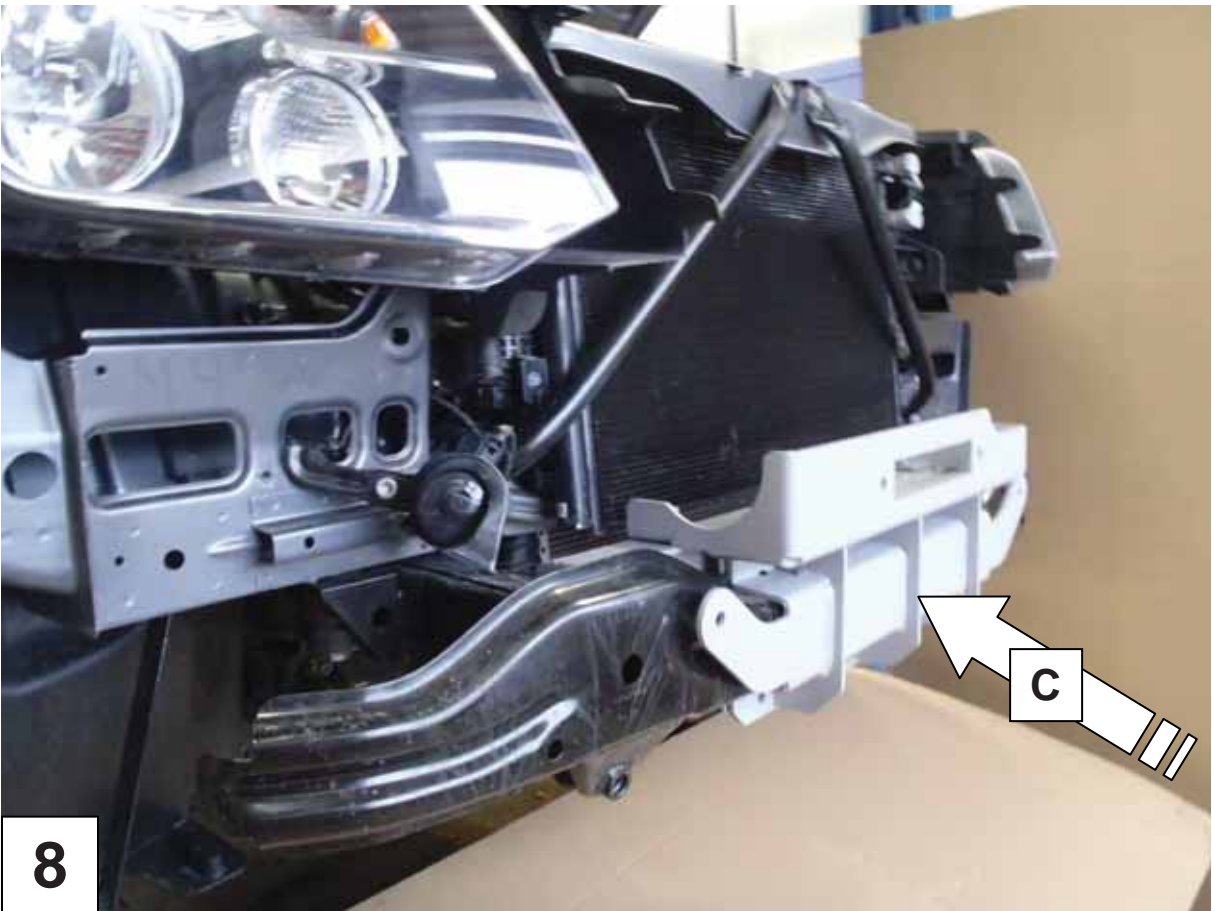

8

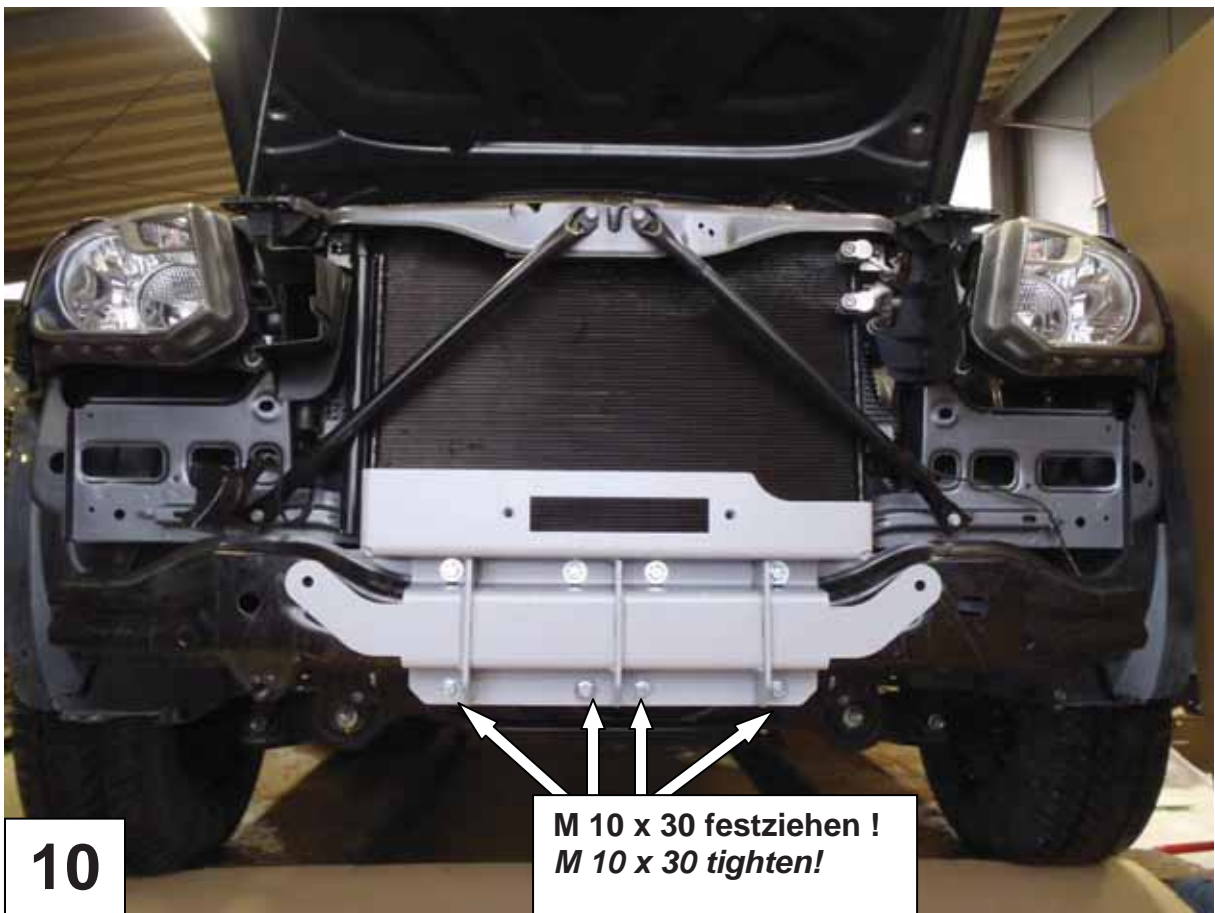

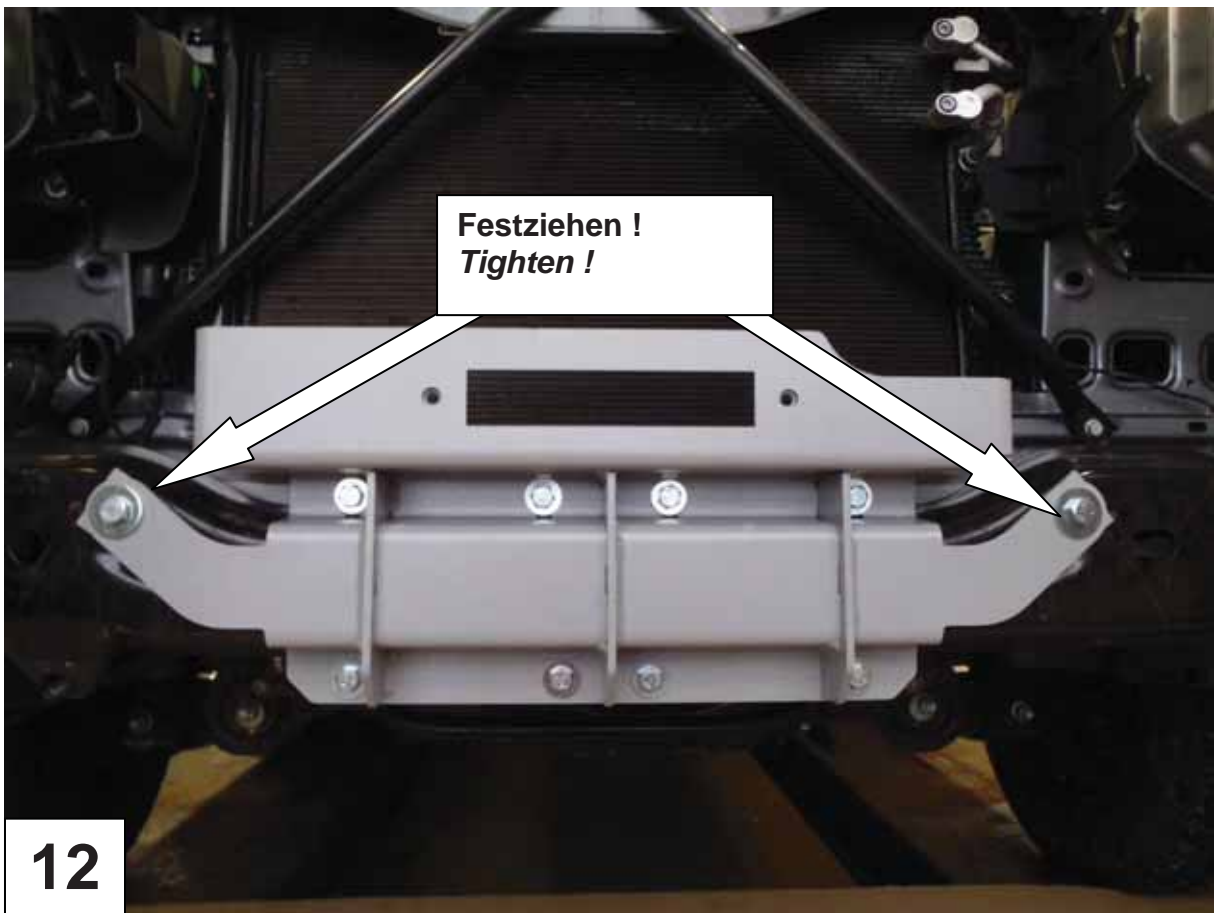
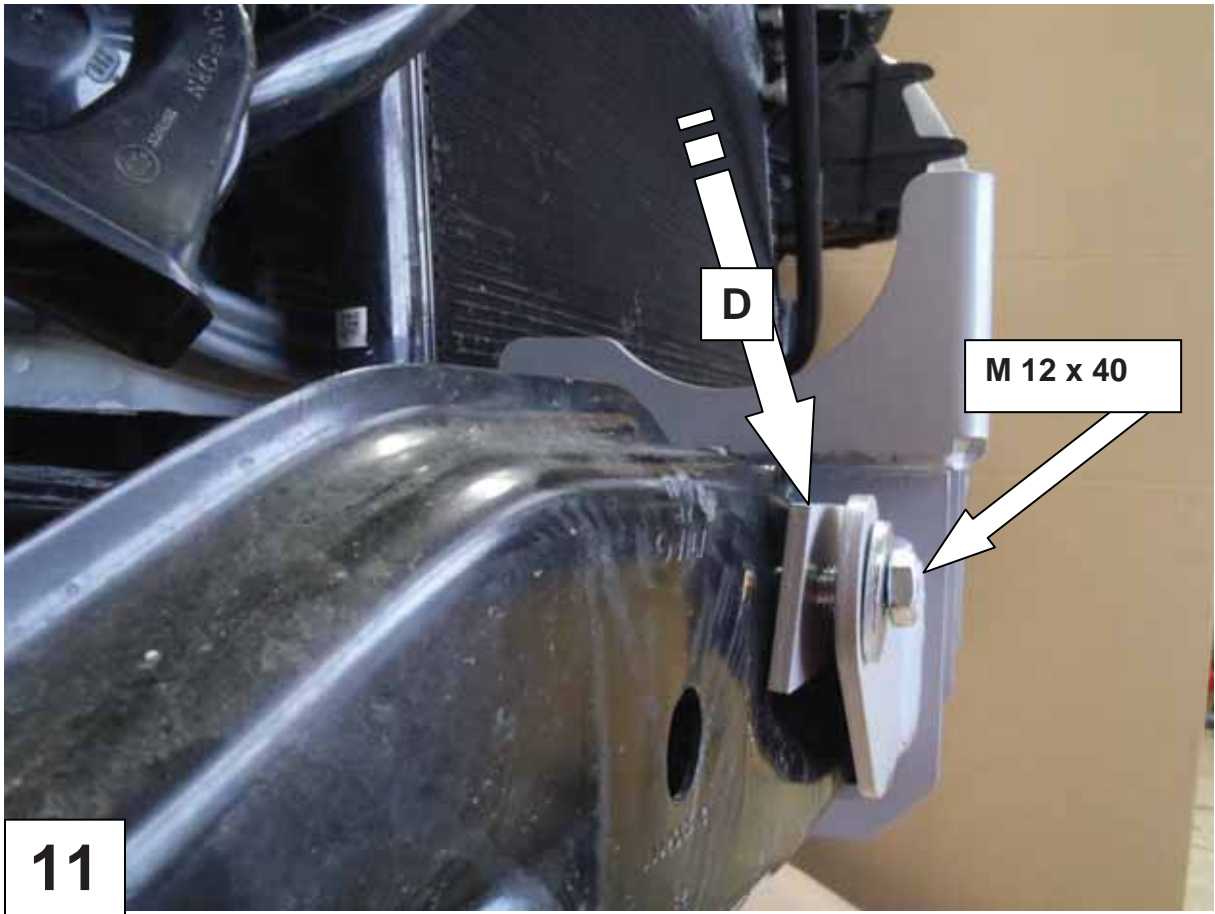

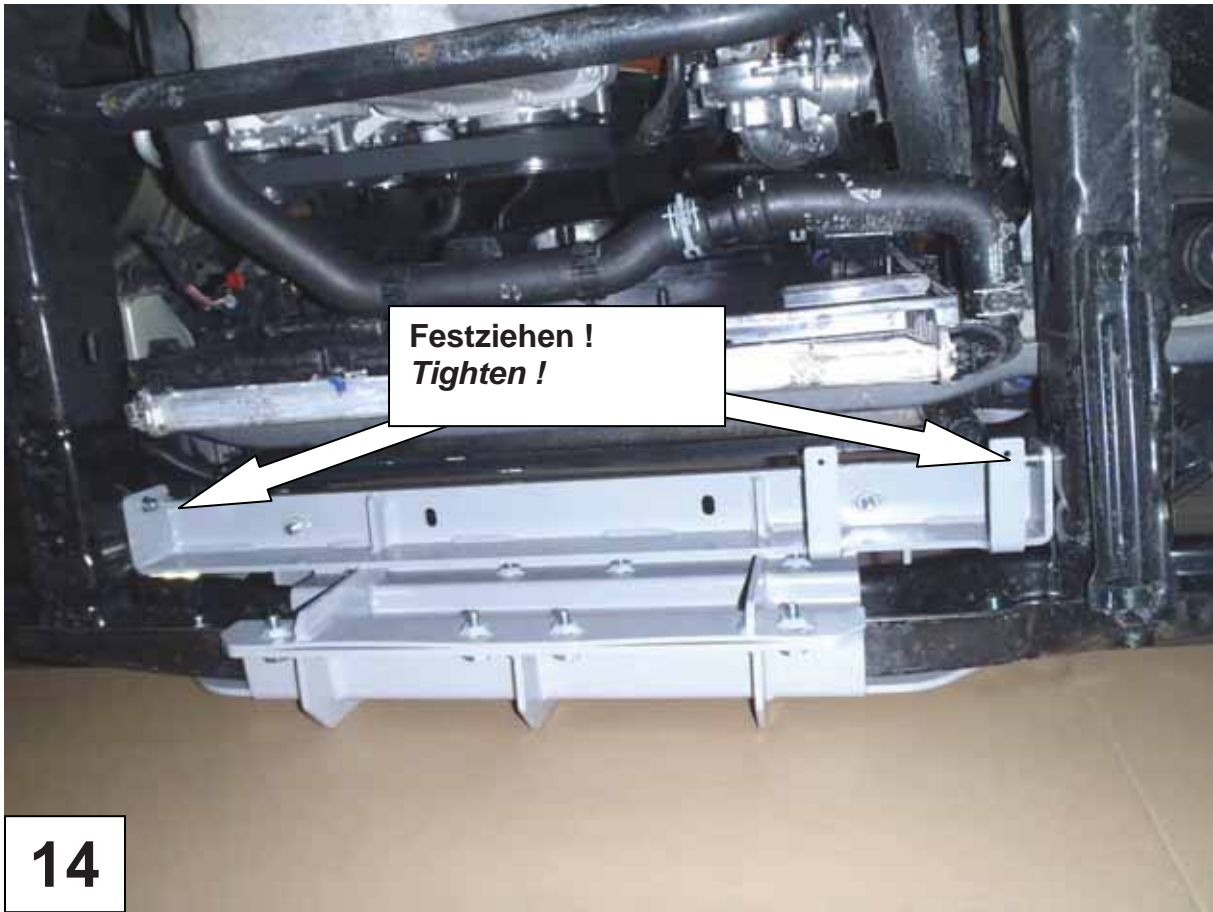
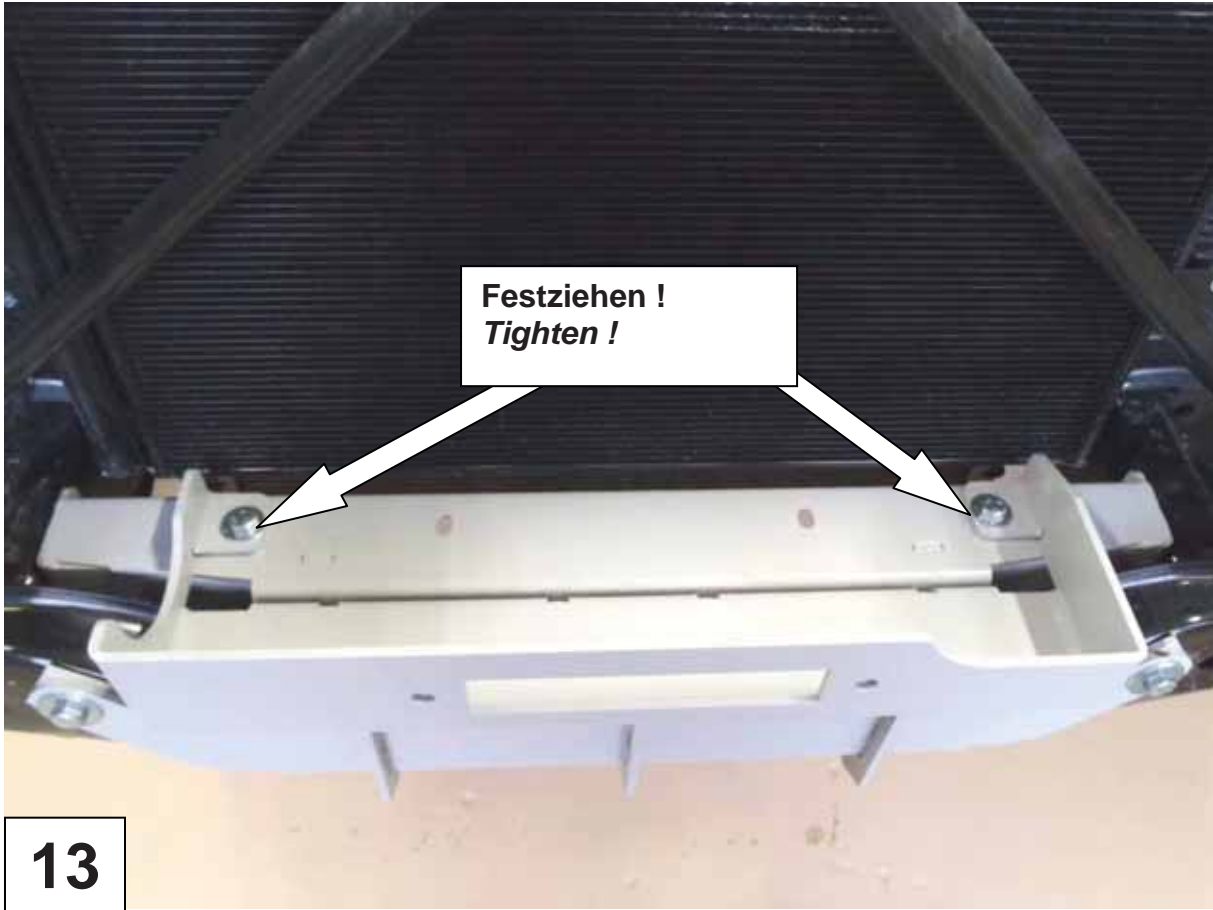

Bei Verwendung einer ZEON-Winde,
weiter mit Bild 24 !
*If you want to fit a ZEON-winch go on with
picture 24 !*

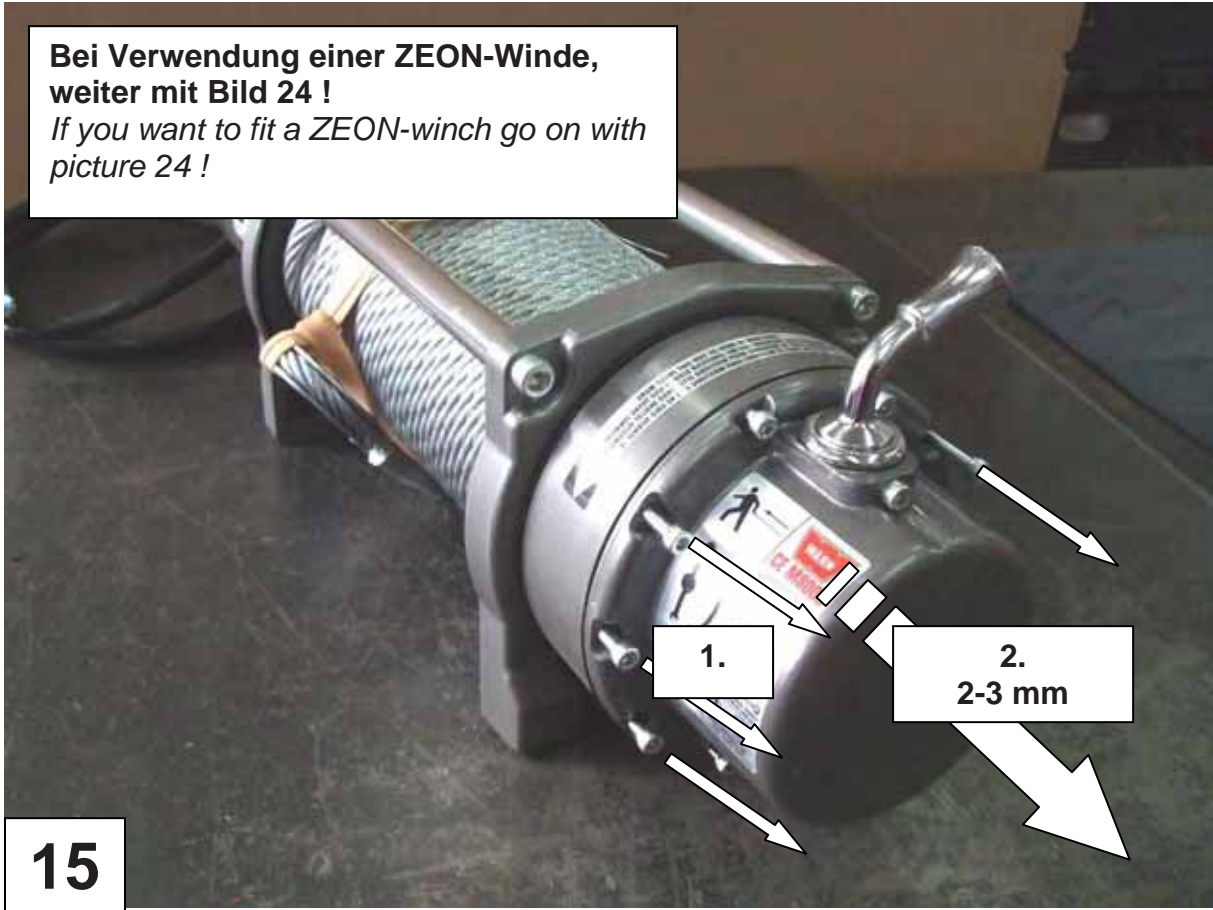

15

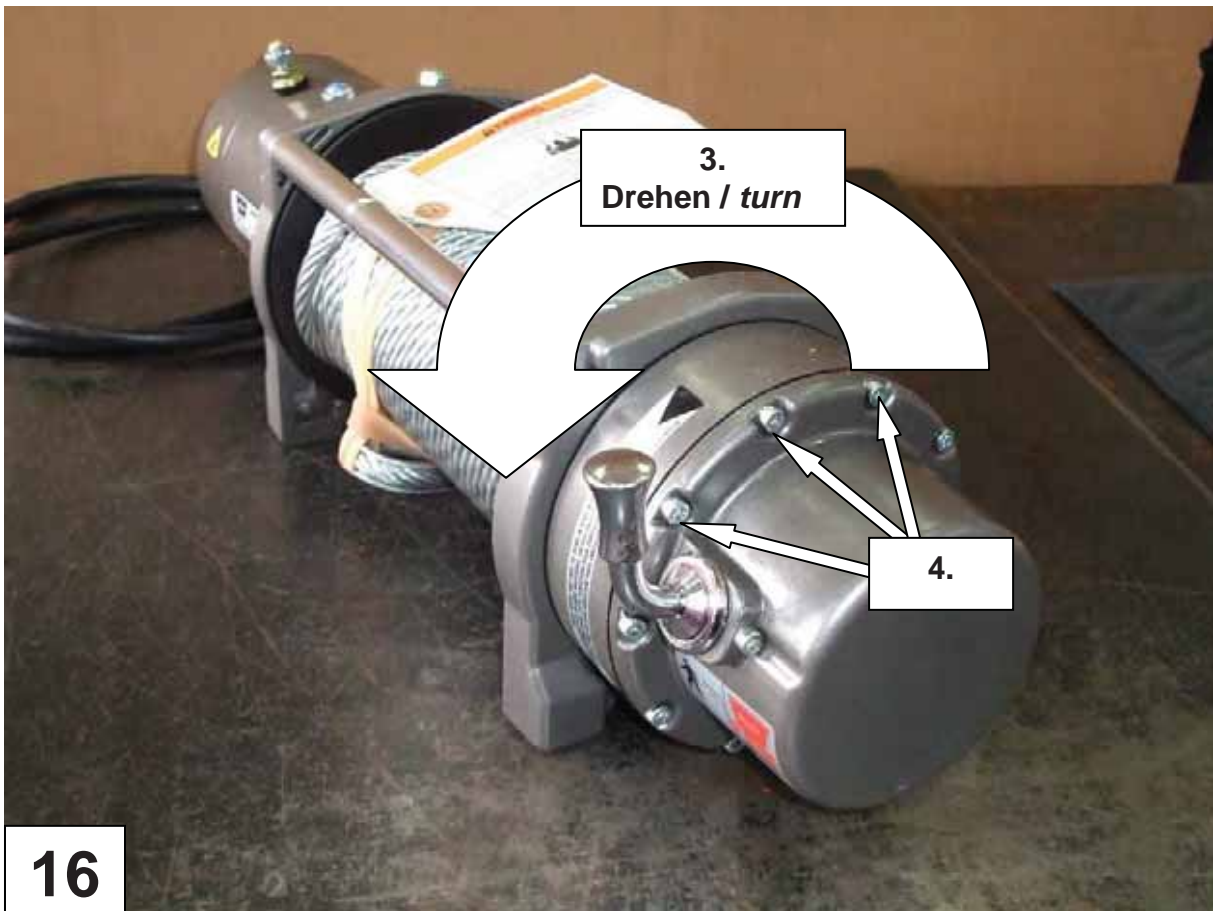

16

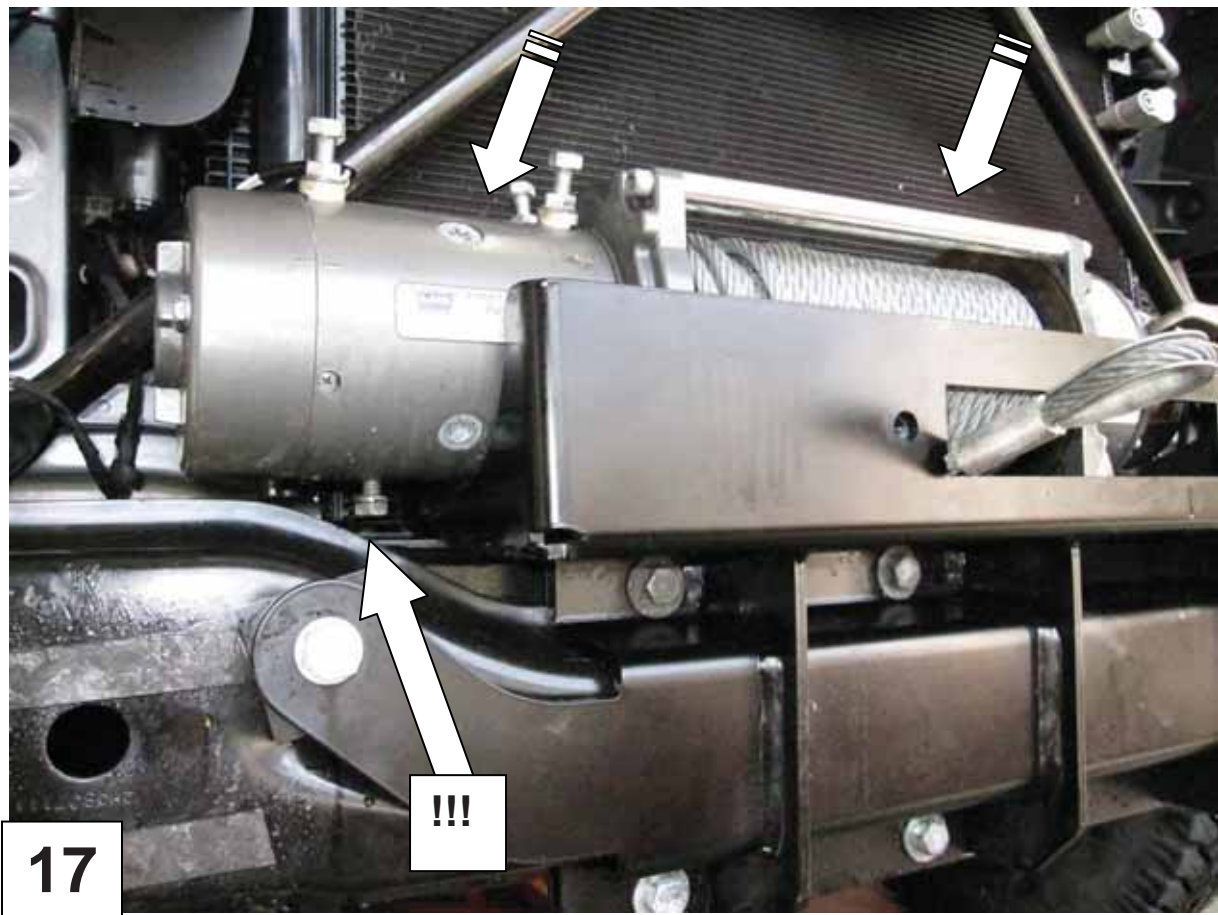

17

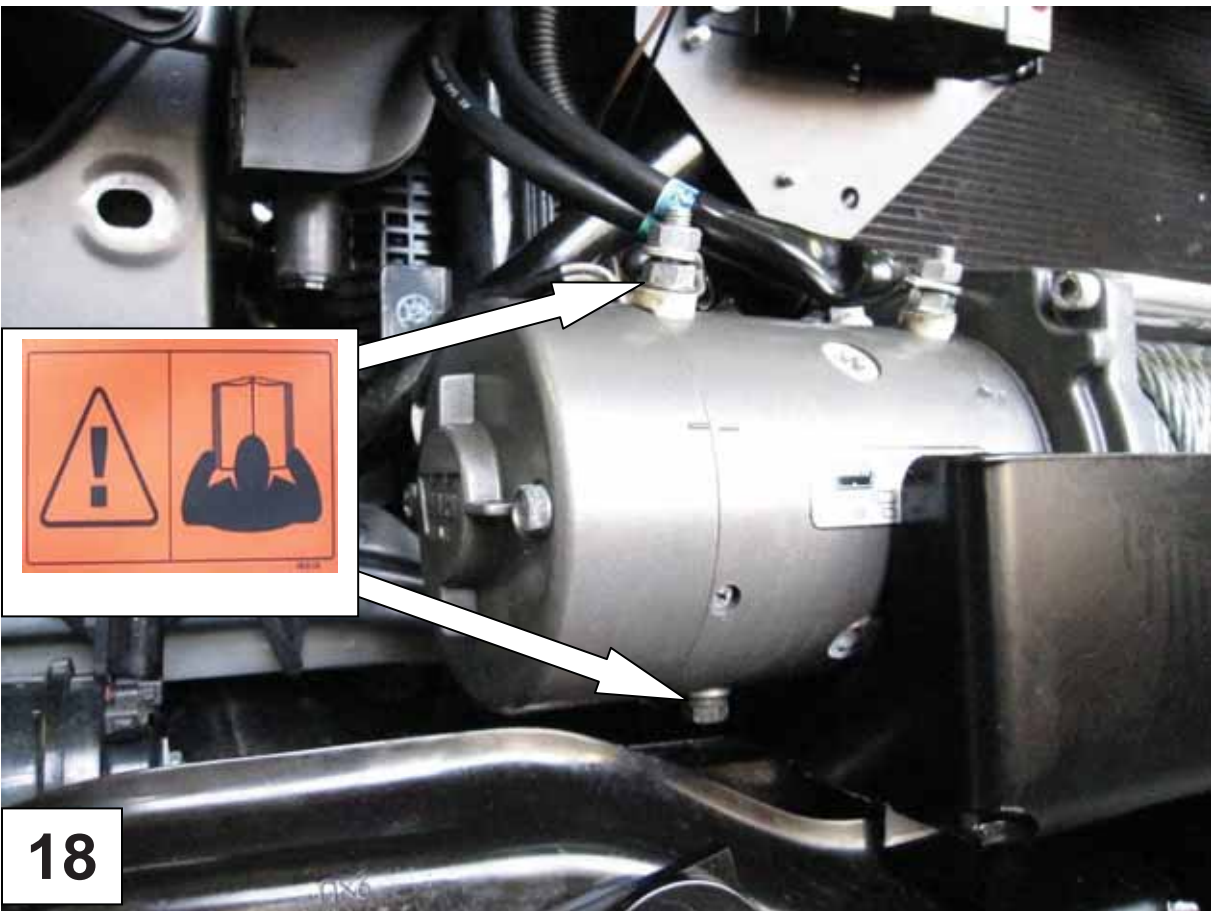

18

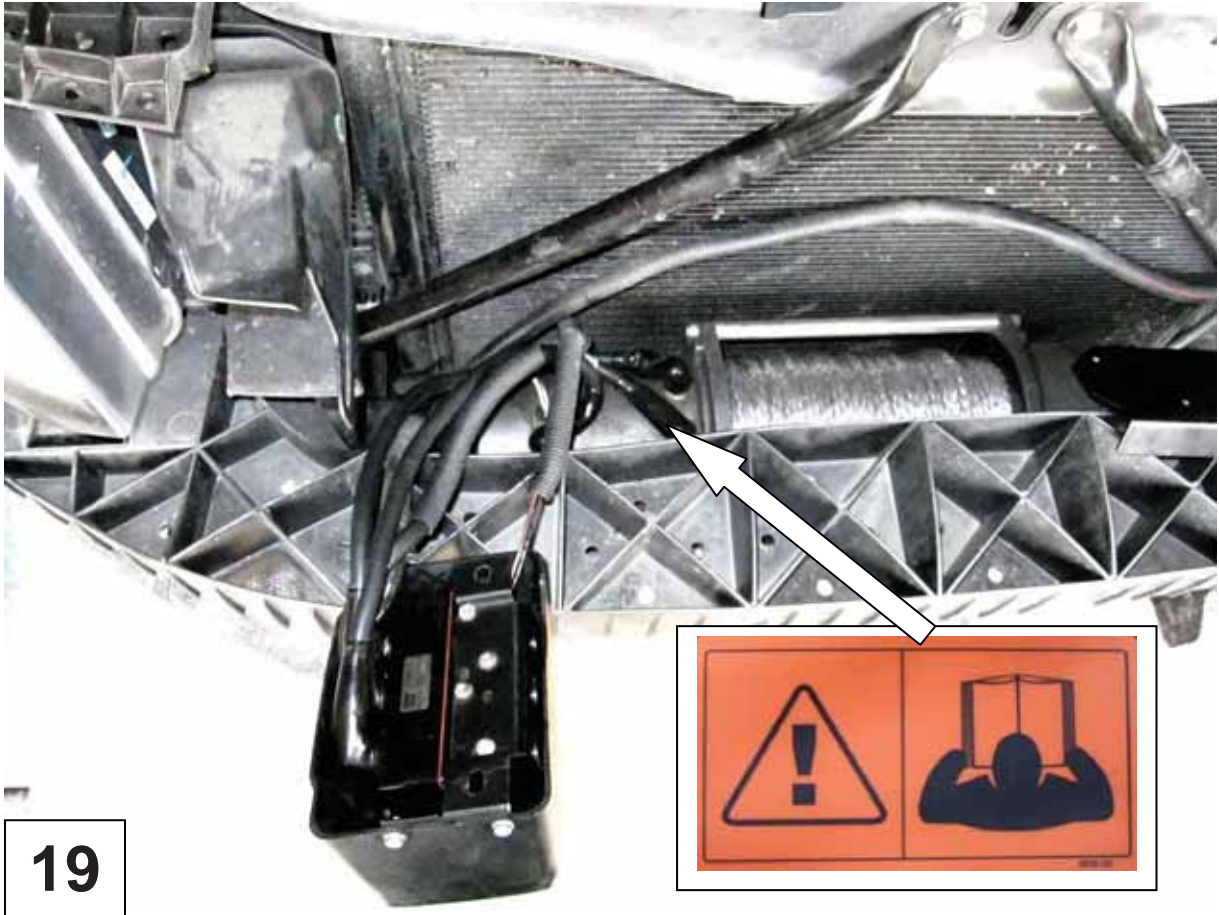

19



20

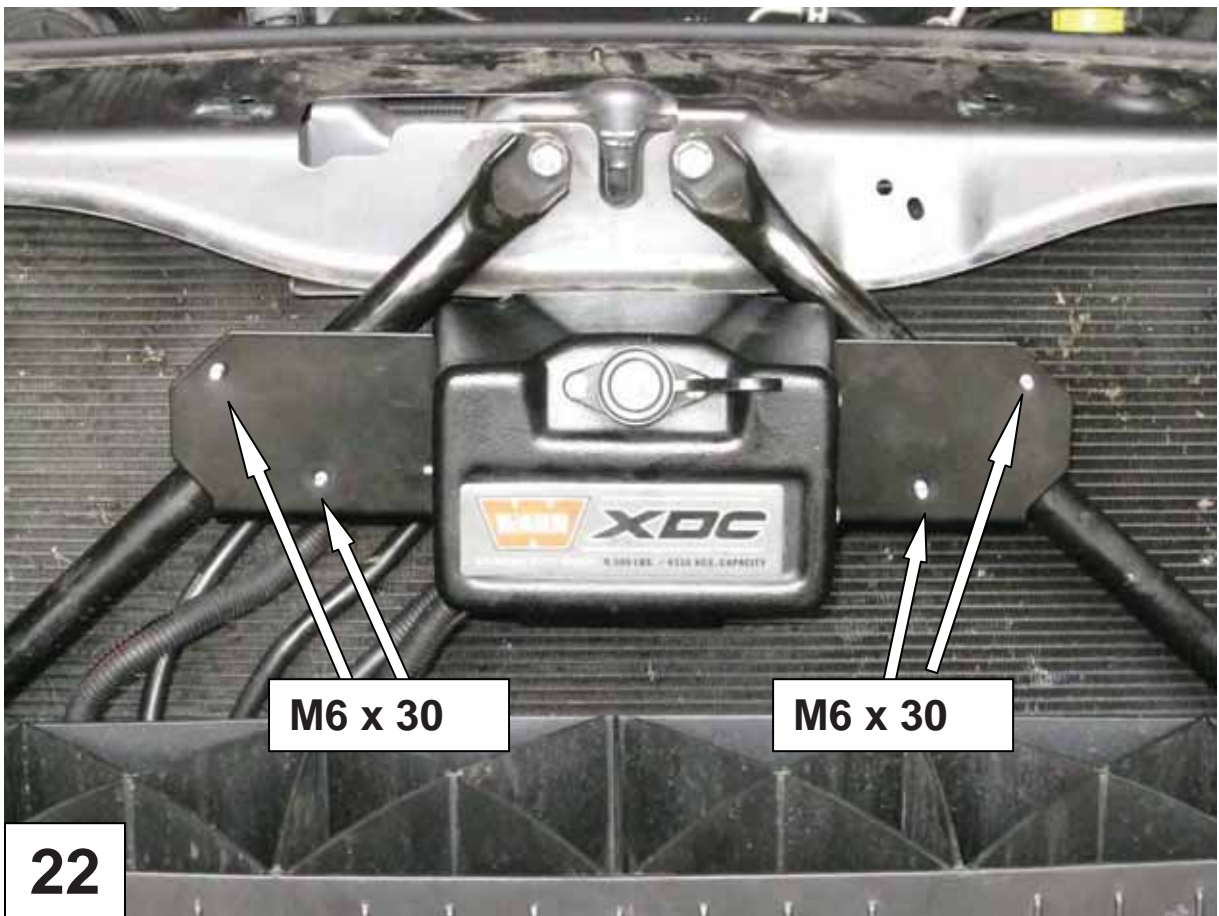
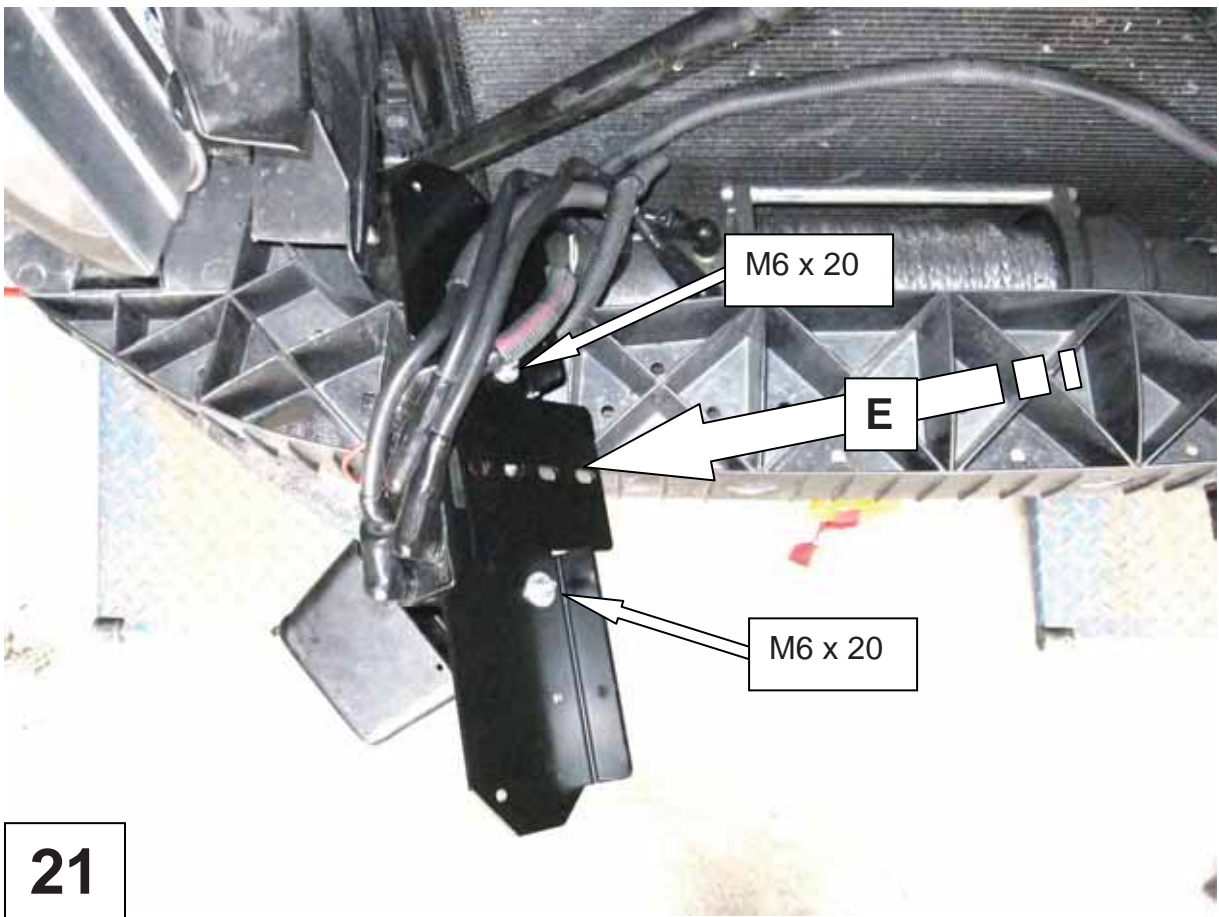

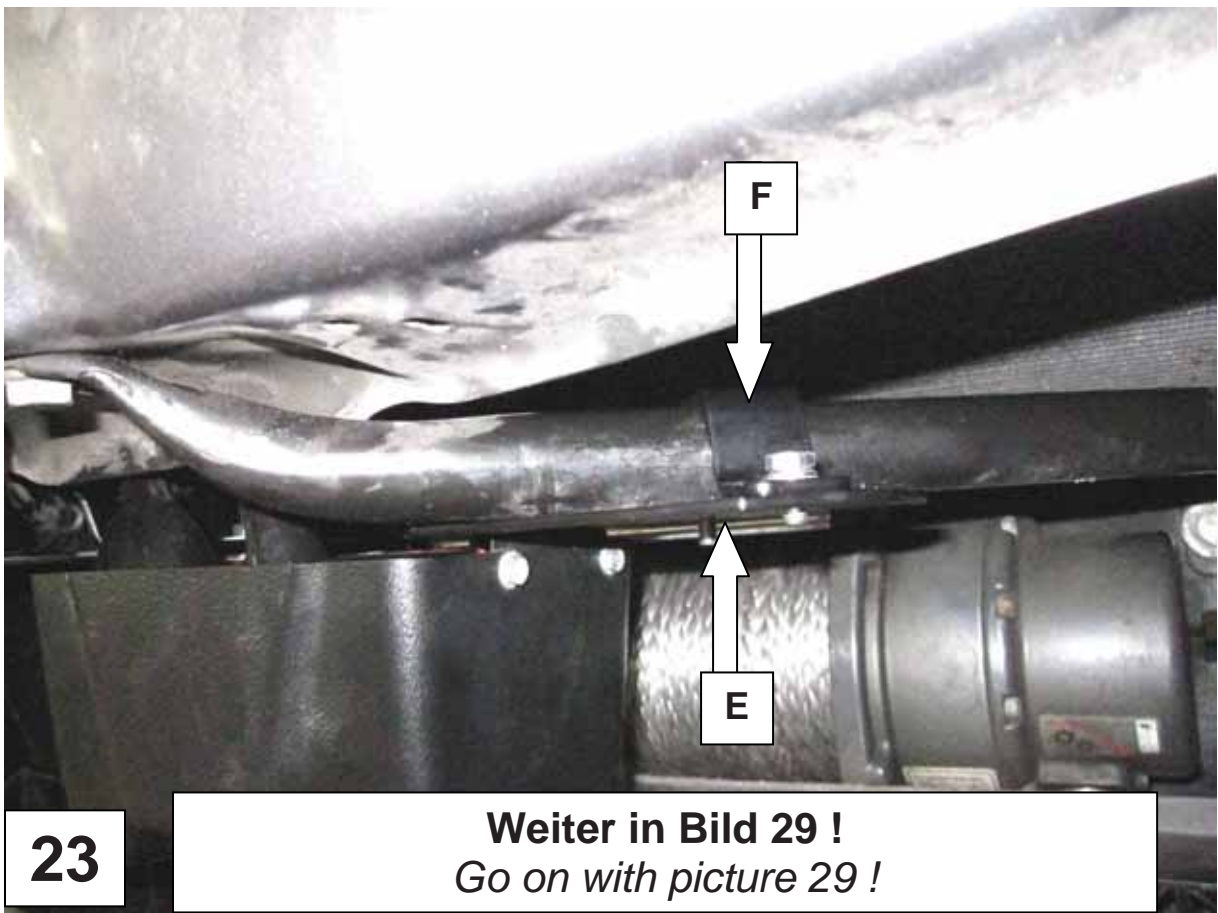

23

Weiter in Bild 29 !
Go on with picture 29 !



WARN - ZEON

1.
lösen / unscrew

24

WARN - ZEON

2.
Drehen / turn

25



WARN - ZEON

Wir empfehlen den Einbau der Steckdosenverlängerung 1-90394 !

We recommend the installation of socket extension kit 1-90394 !



27

WARN - ZEON

Befestigen sie die Steckdose des Verlängerungskits an einem platz ihrer Wahl.

Fit the socket of the extension kit to a position of your choice !



28

WARN - ZEON



29



Befestigen Sie die Winde ,wie in der Bedienungsanleitung beschrieben !

Fix the winch as described in the winch manual!

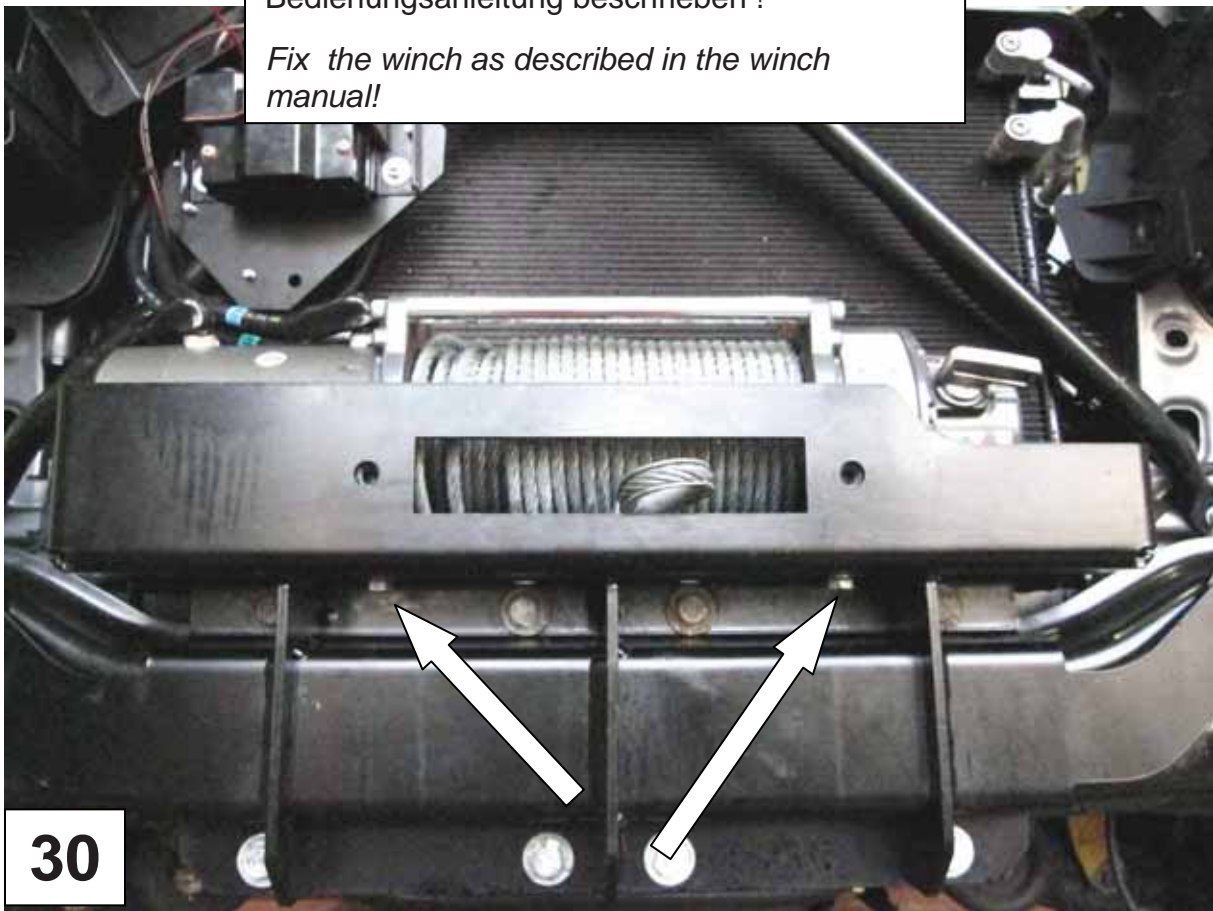

30

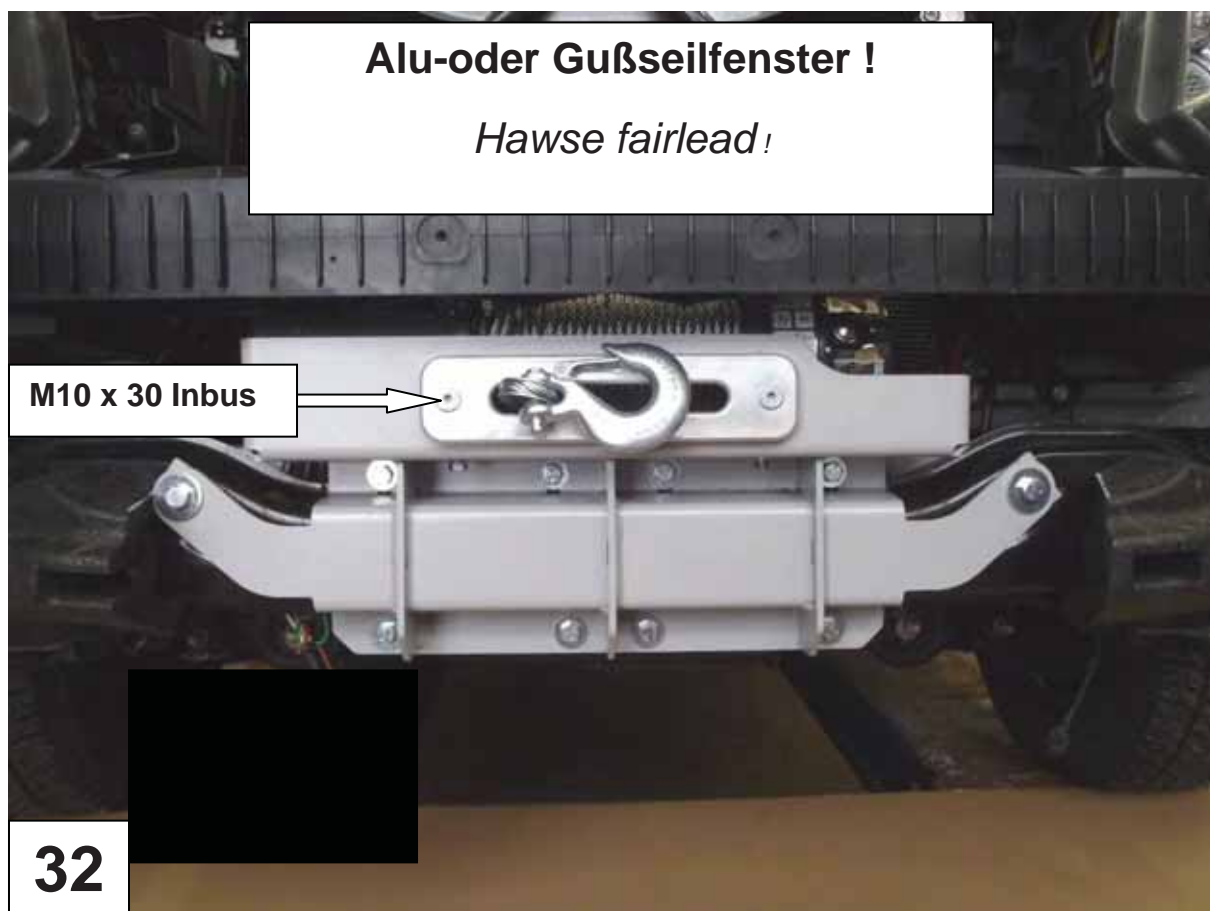
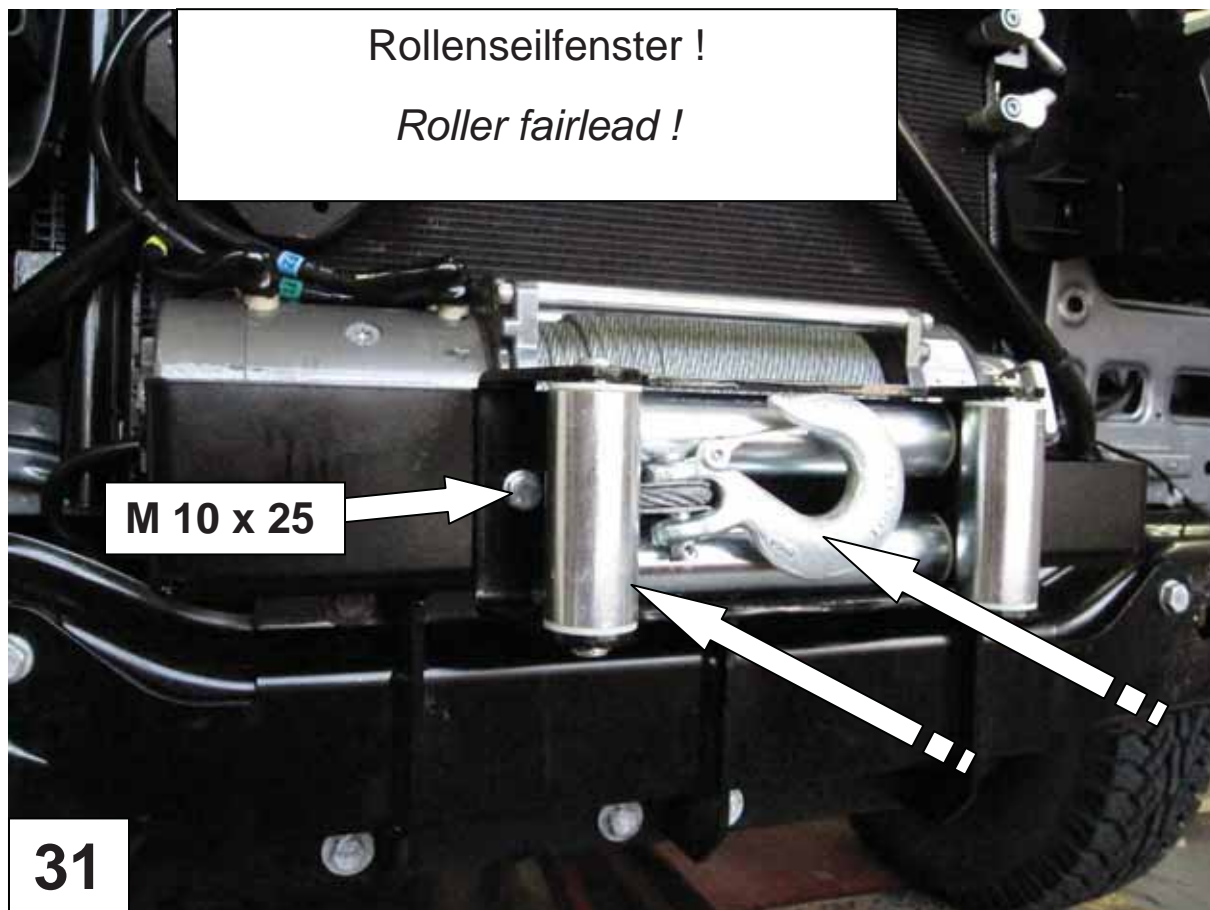

Bei Verwendung einer ZEON-Winde,
weiter mit Bild 29 !
*If you want to fit a ZEON-winch go on with
picture 29 !*

Ausschneiden siehe auch Bild 26 !
Cut out, please have a look at pict.26!

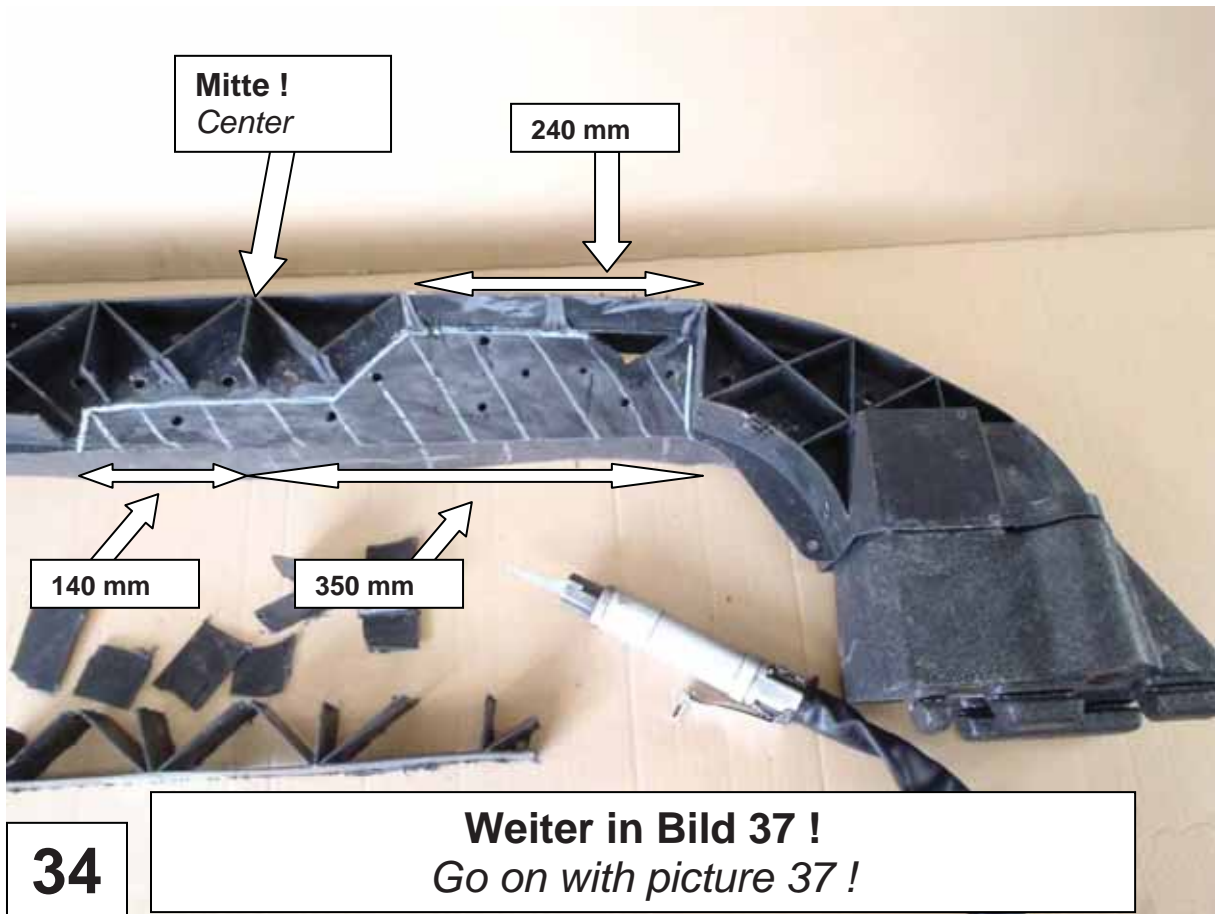
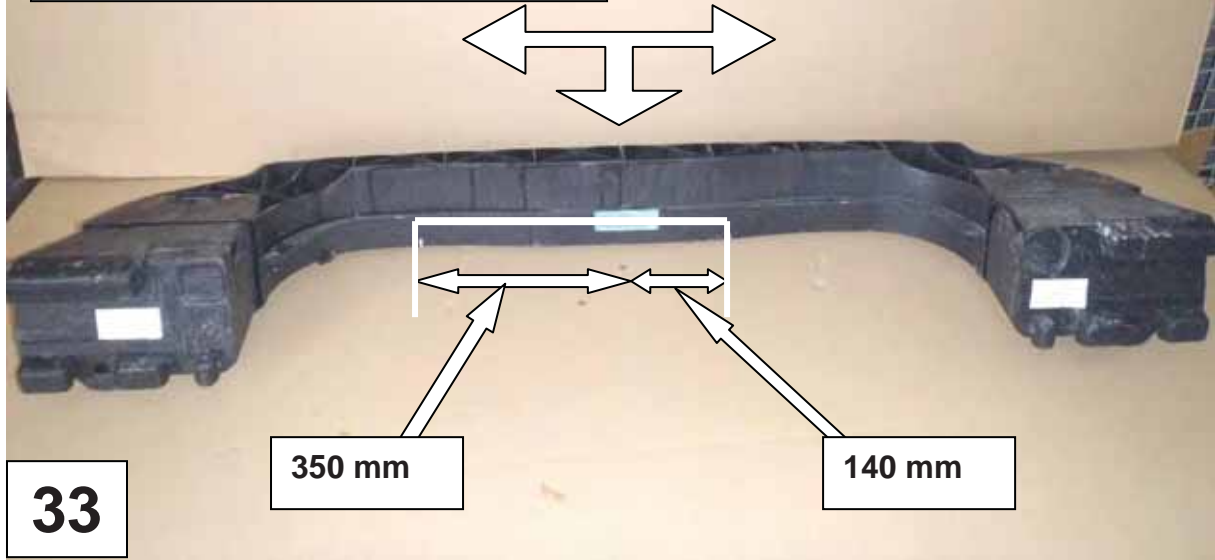

WARN - ZEON



35

WARN - ZEON



36

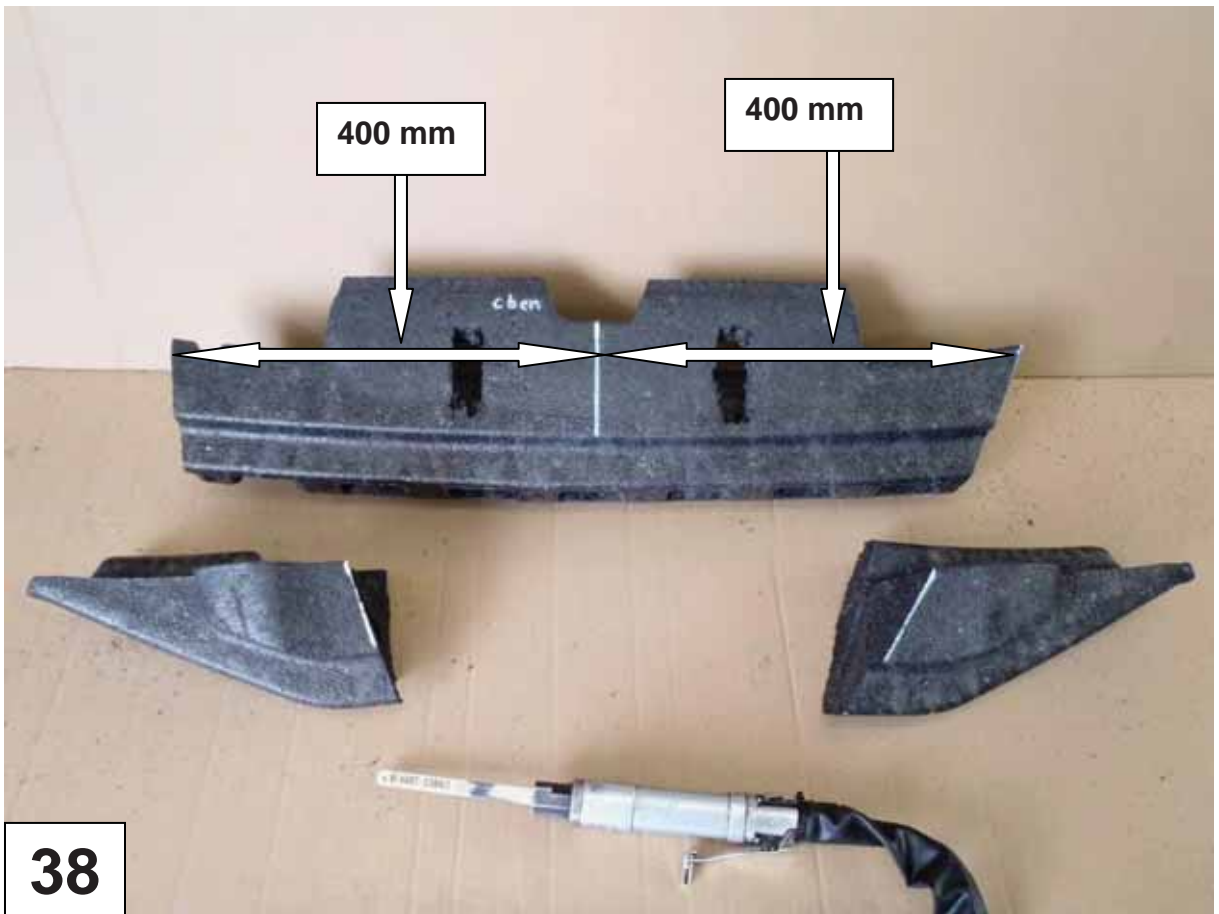



**Ausschnitt für Aluminium –
oder Gusseifenfenster !
„Trendline“ Stoßfänger**

*Cutout for hawse fairlead !
„Trendline“ bumper*

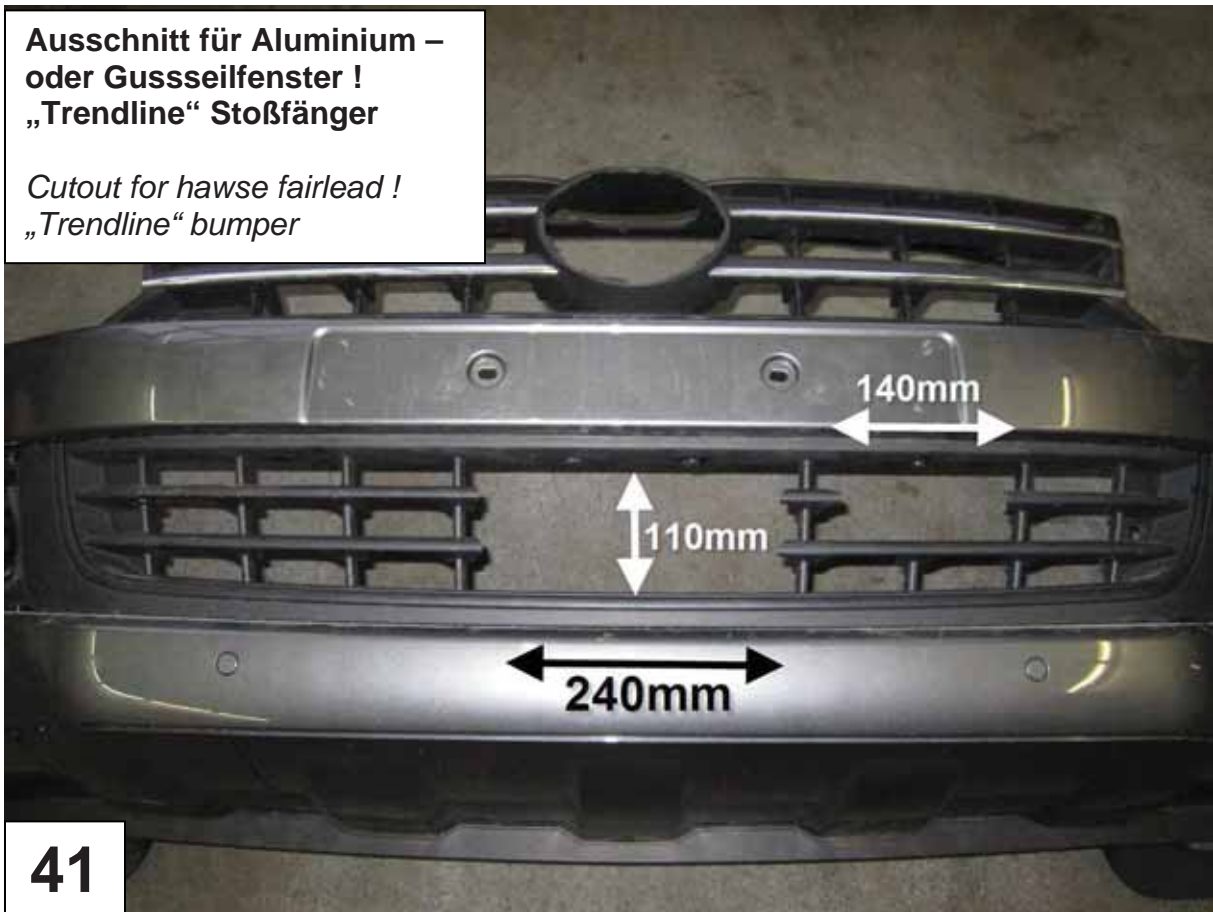

WARN - ZEON

**Ausschnitt für Aluminium –
oder Gusseifenfenster !
„Trendline“ Stoßfänger**

*Cutout for hawse fairlead !
„Trendline“ bumper*



**Ausschnitt für
Rollenseilfenster !
„Basic line“ Stoßfänger**

*Cutout for roller- fairlead !
„Basic line“ bumper*



**Ausschnitt für
Rollenseilfenster !
„Highline“ Stoßfänger**

*Cutout for roller- fairlead !
„Highline“ bumper*

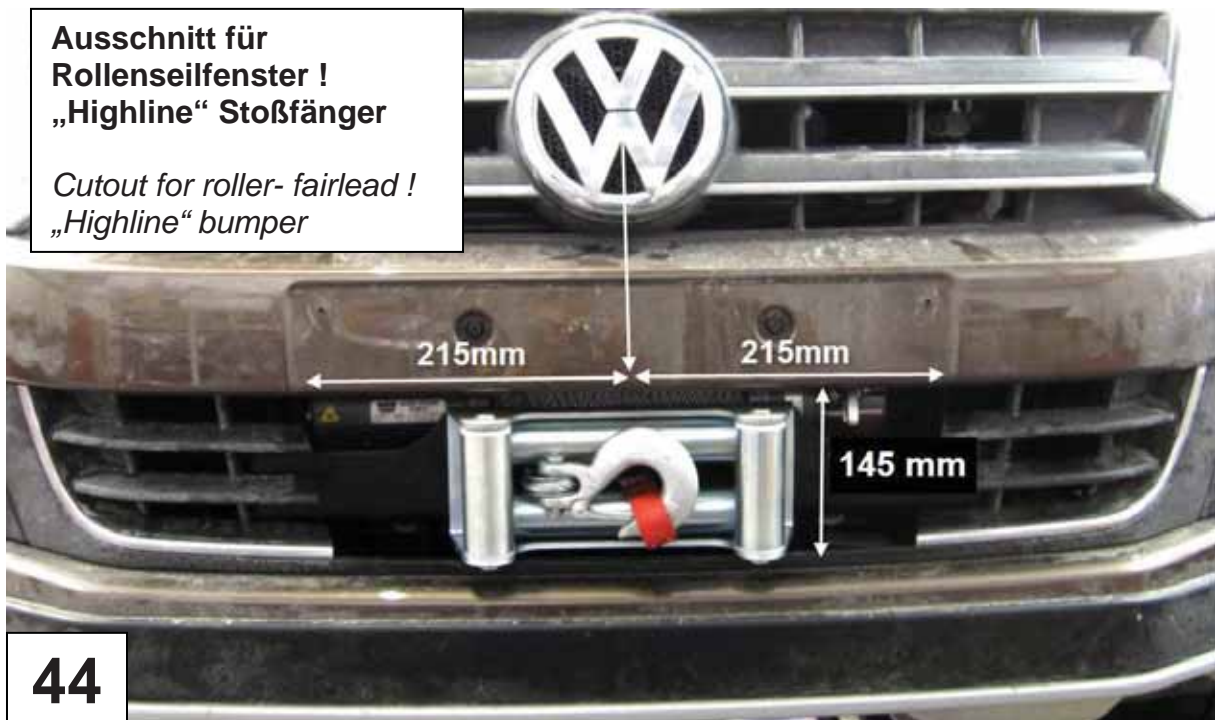

WARN - ZEON



45

**WARN
XDC + M 8000**



46

WARN
XDC + M 8000

Original
original

Bearbeitet
modified

47

WARN
XDC + M 8000

12 mm

48

WARN
XDC + M 8000

Abrunden
Round down

49

WARN
XDC + M 8000

TAUBENREUTHER

50

WARN
XDC + M 8000



51

WARN
XDC + M 8000



52

VW Amarok
Rollenseifensterabdeckung zuschneiden!
Modify the roller fairlead cover !



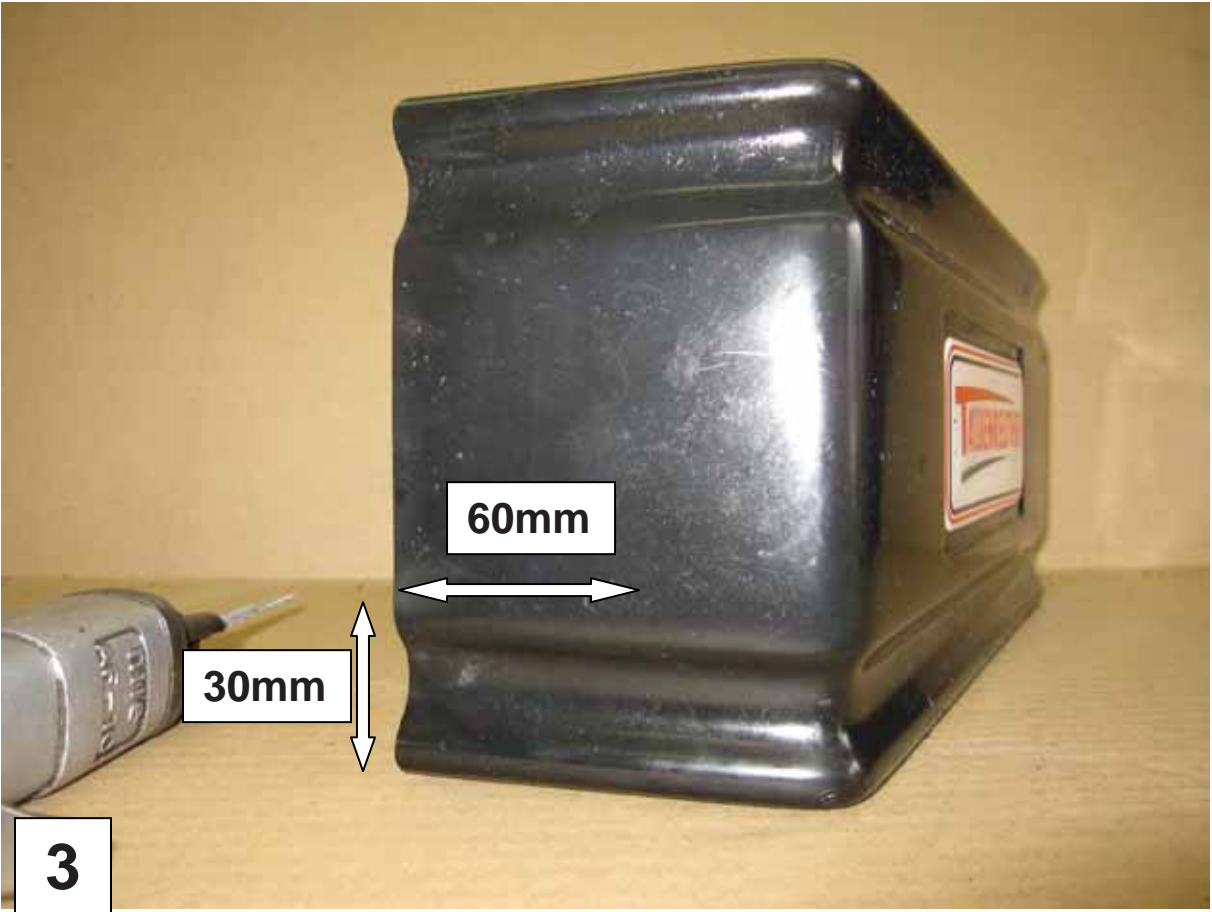



5



6