

Anbauanleitung Seilwindenanbausatz Mercedes Sprinter/ VW Crafter ab Bj.06

Best.-Nr.: 16-6011

AL: 1182 – 00



**Hier sehen sie den fertig montierten Seilwindenanbausatz.
Bevor sie mit der Montage beginnen, lesen sie bitte diese Anleitung
und das Benutzerhandbuch der Seilwinde gut durch.**

Achtung:

Bei Fahrten im öffentlichen Straßenverkehr muß das Rollenseilfenster mit der Kunststoffabdeckung Best.nr.: **15 – 899** abgedeckt werden.

Before you start fitting, please read and understand this instruction manual and the owners manual of the winch.

Stückliste

Seilwindenbausatz Mercedes Sprinter und VW Crafter ab Bj.06

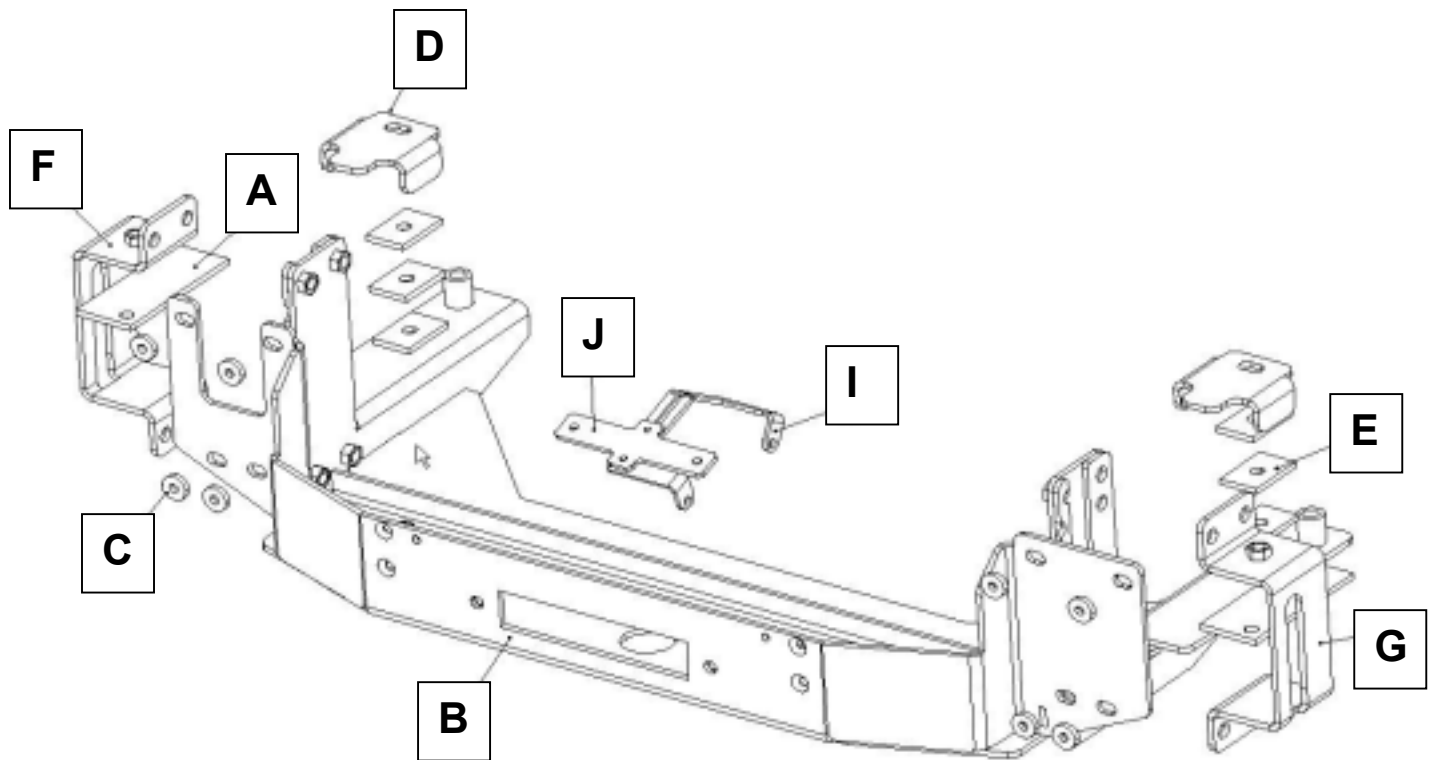

<p>2 x Anpressplatte (A) 1 x Seilwindenaufnahme (B) 8 x U – Scheibe (C) 2 x Klemmstück (D) 6 x Distanzplatte (E) 1 x Seitenhalter rechts (F) 1 x Seitenhalter links (G) 2 x Kabelhalter (H) nicht im Bild 1 x Schaltkastenhalter (I) 1 x Schaltkastenadapter XDC (J)</p> <p>1 x Kunststoffabdeckung 15 - 899</p> <p>1 x Gutachten 1 x Anleitung AL 1182</p>	<p>2 x Schraube m 12 x 180 7 x Schraube M 12 x 35 1 x Schraube M 12 x 30 2 x Schraube M 12 x 60 12 x U – Scheibe M 12 10 x Federring M 12 4 x Mutter M 12</p> <p>2x Schraube M 10 x 25 2 x U-Scheibe M 10 2 x Federring M 10</p> <p>8 x Schraube M 8 x 30 8 x U Scheibe M 8 8 x Federring M 8</p> <p>2x Schraube M 6 x 12 4x Schraube M 6 x 20 6 x U -Scheibe M 6 x 20 2 x U –Scheibe M 6 x30 4 x Federring M 6 2 x Mutter M 6</p>
--	---





3



4

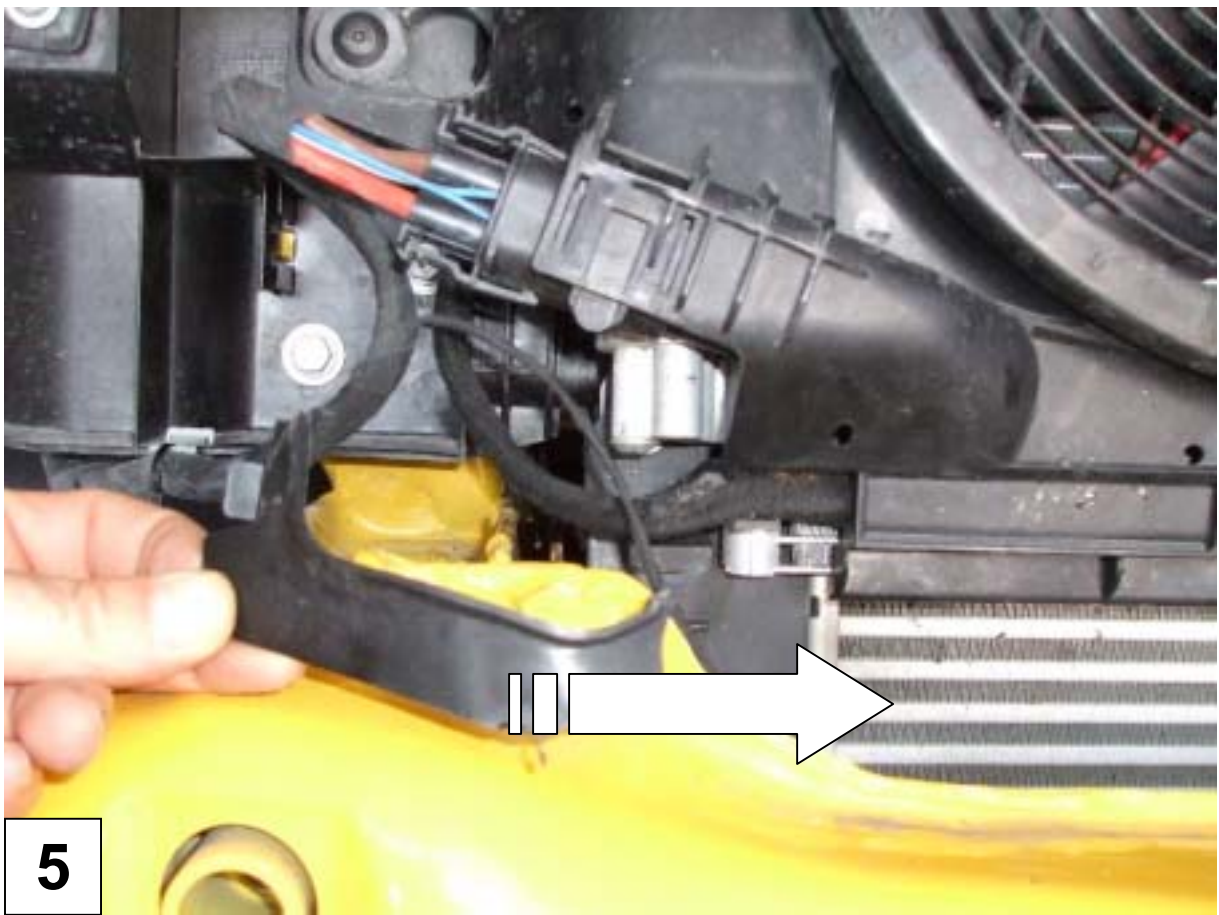

5



6

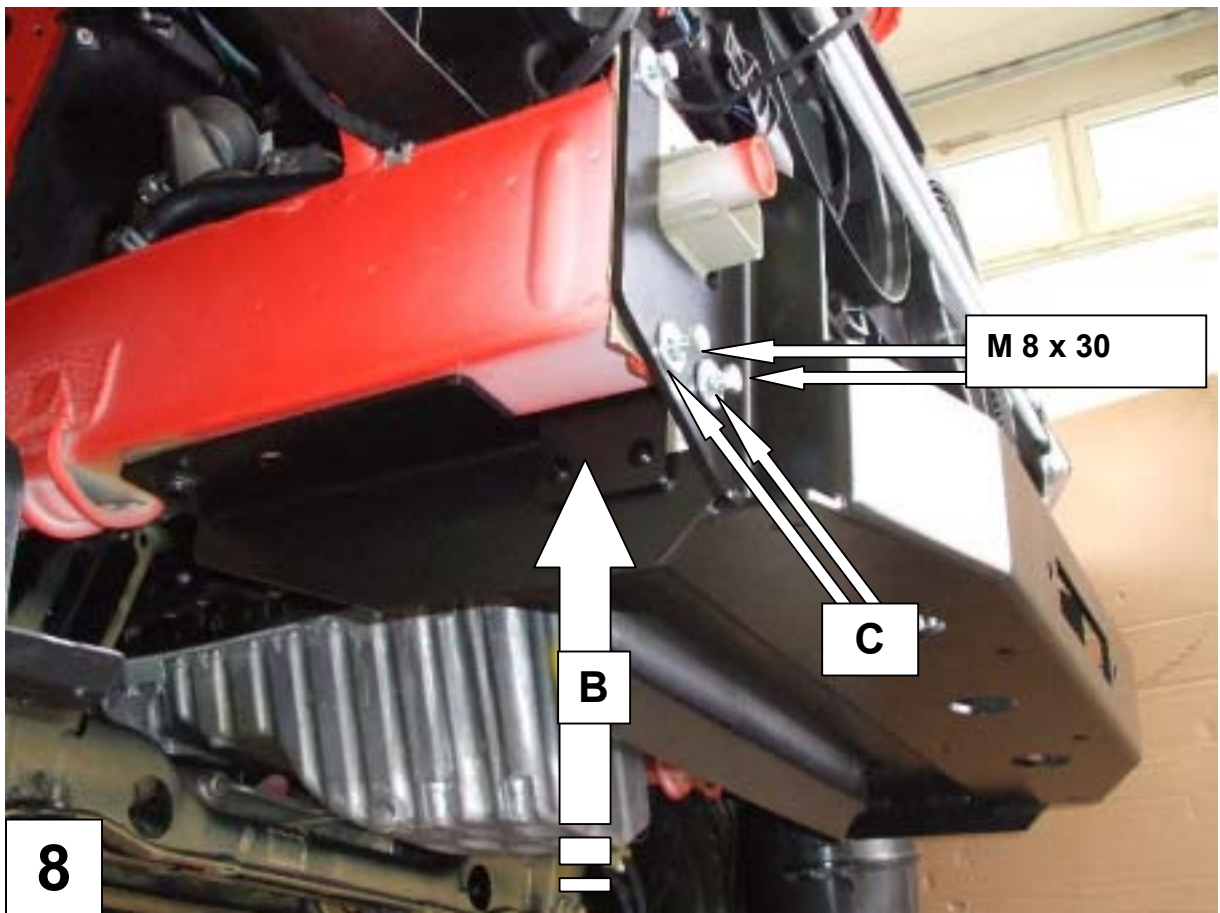
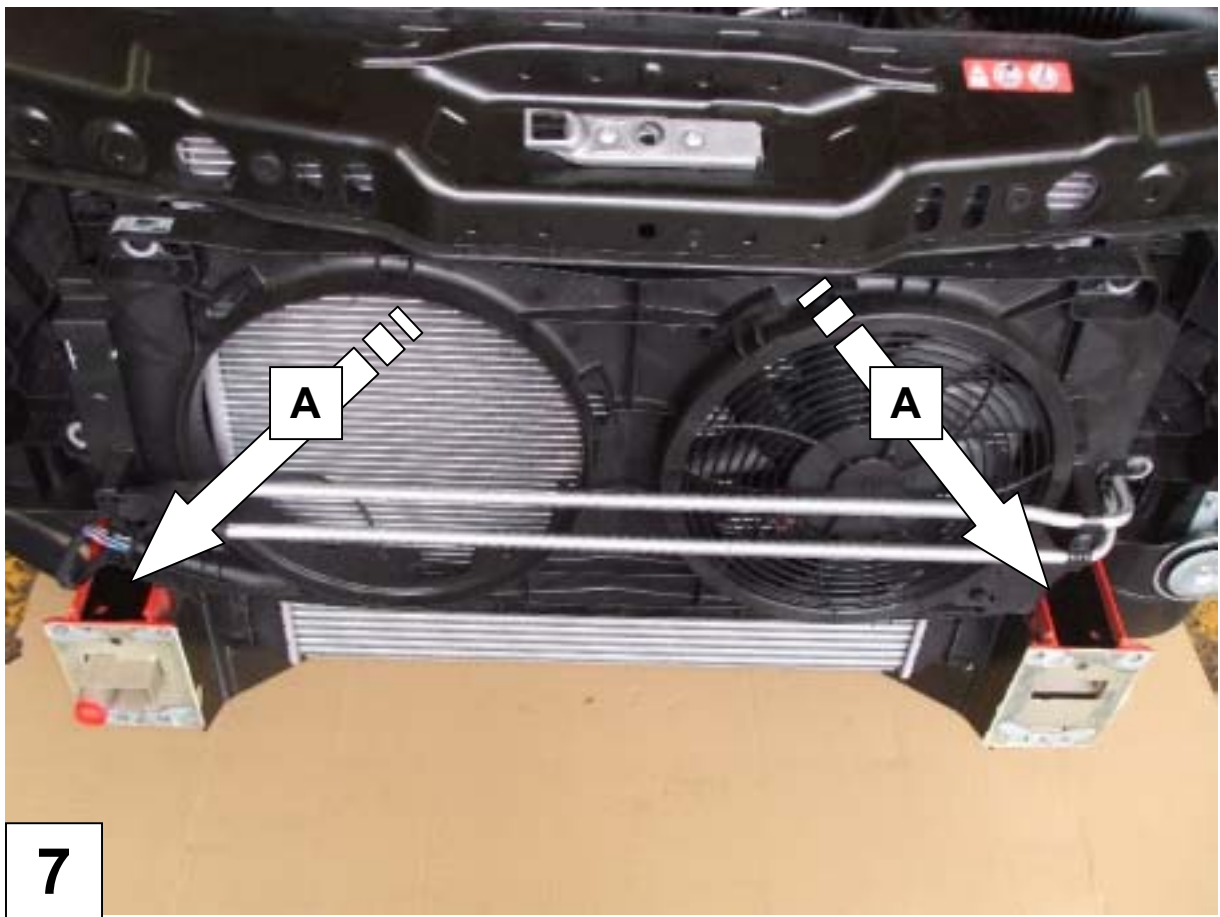

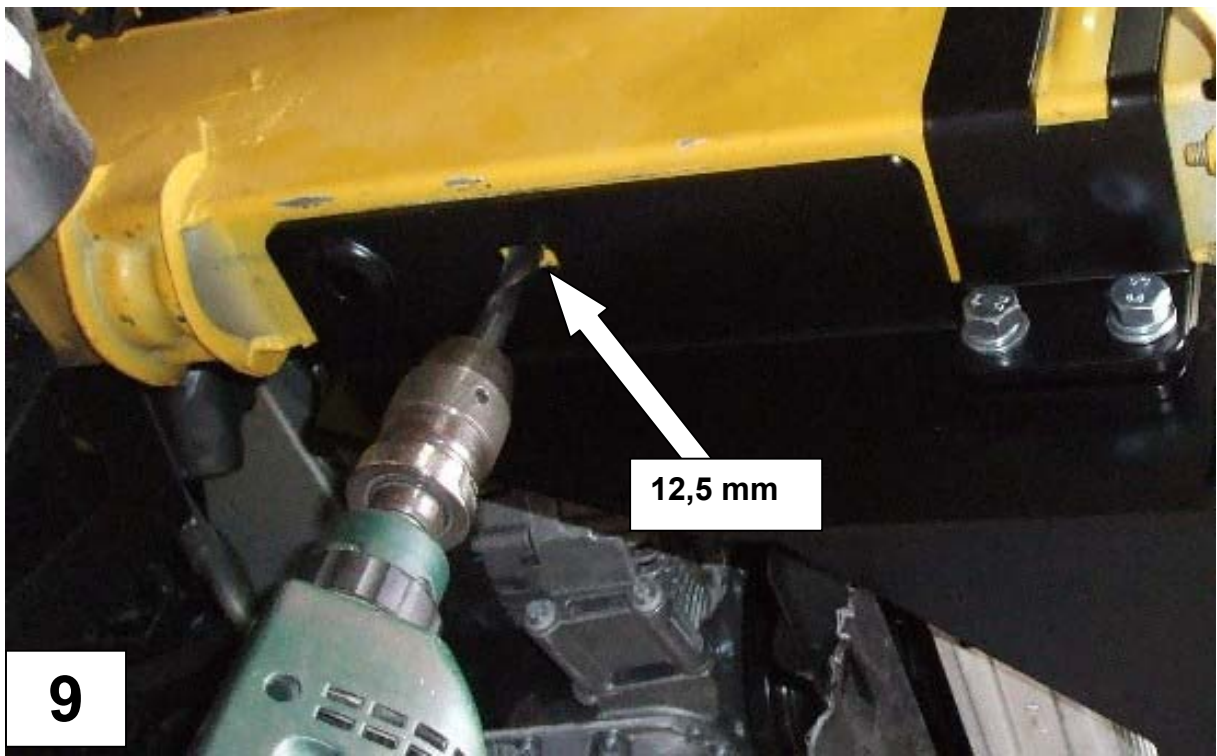

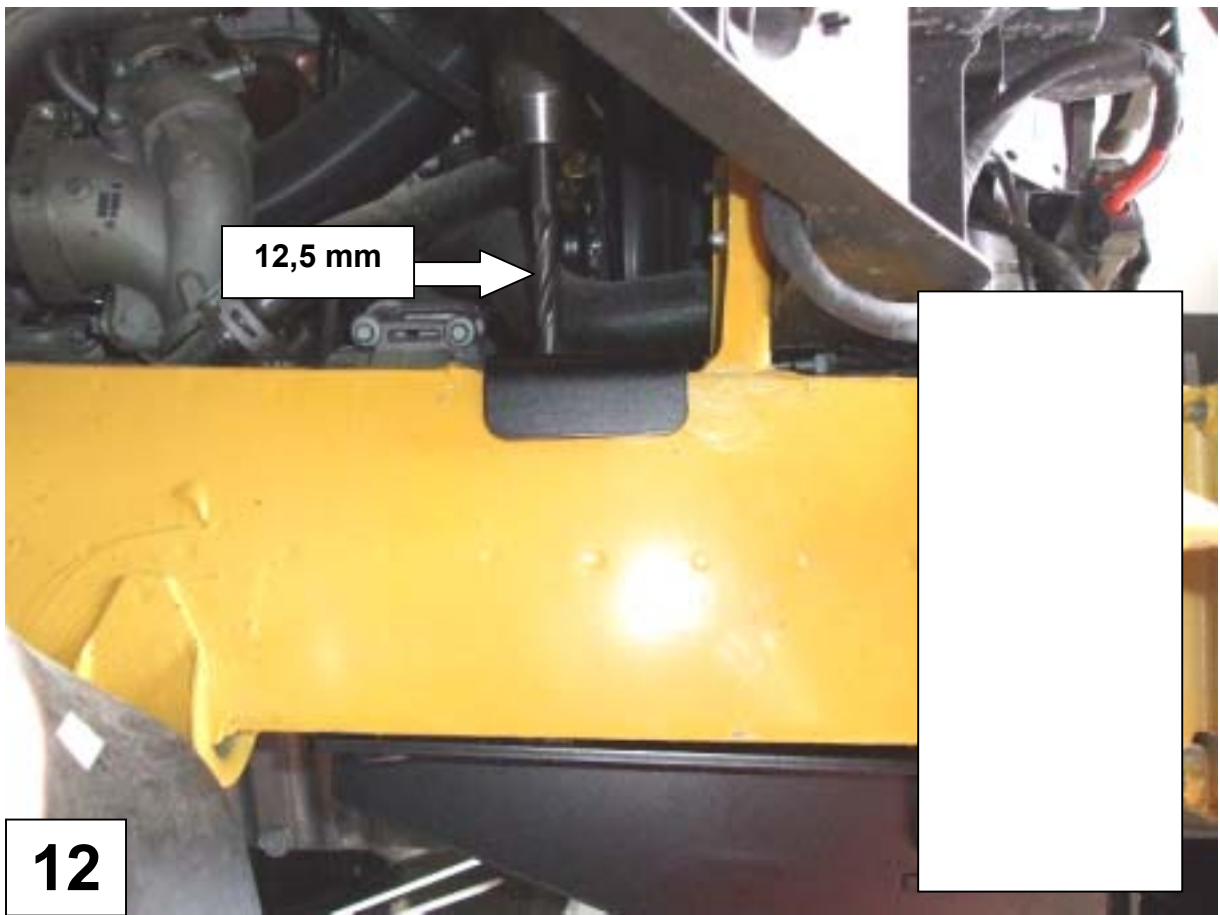
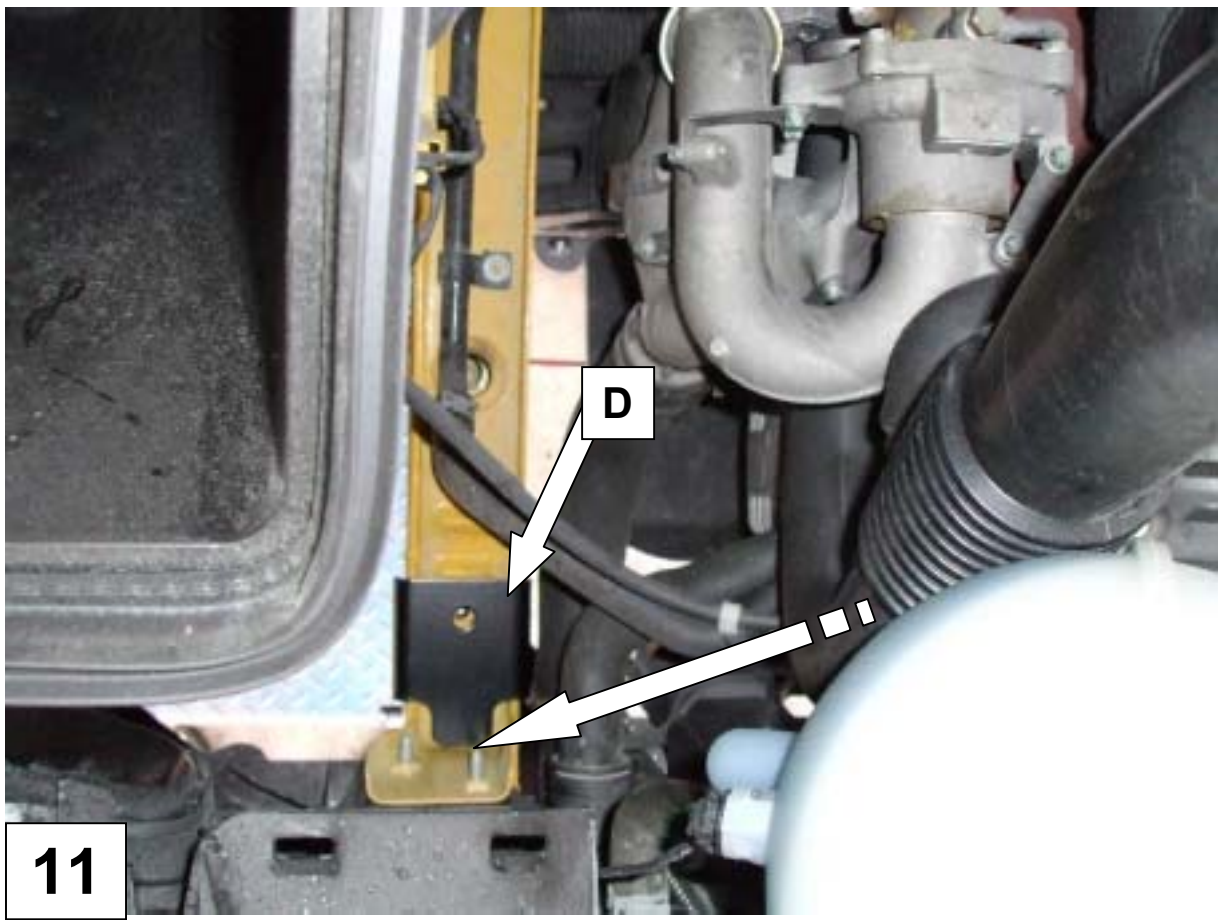

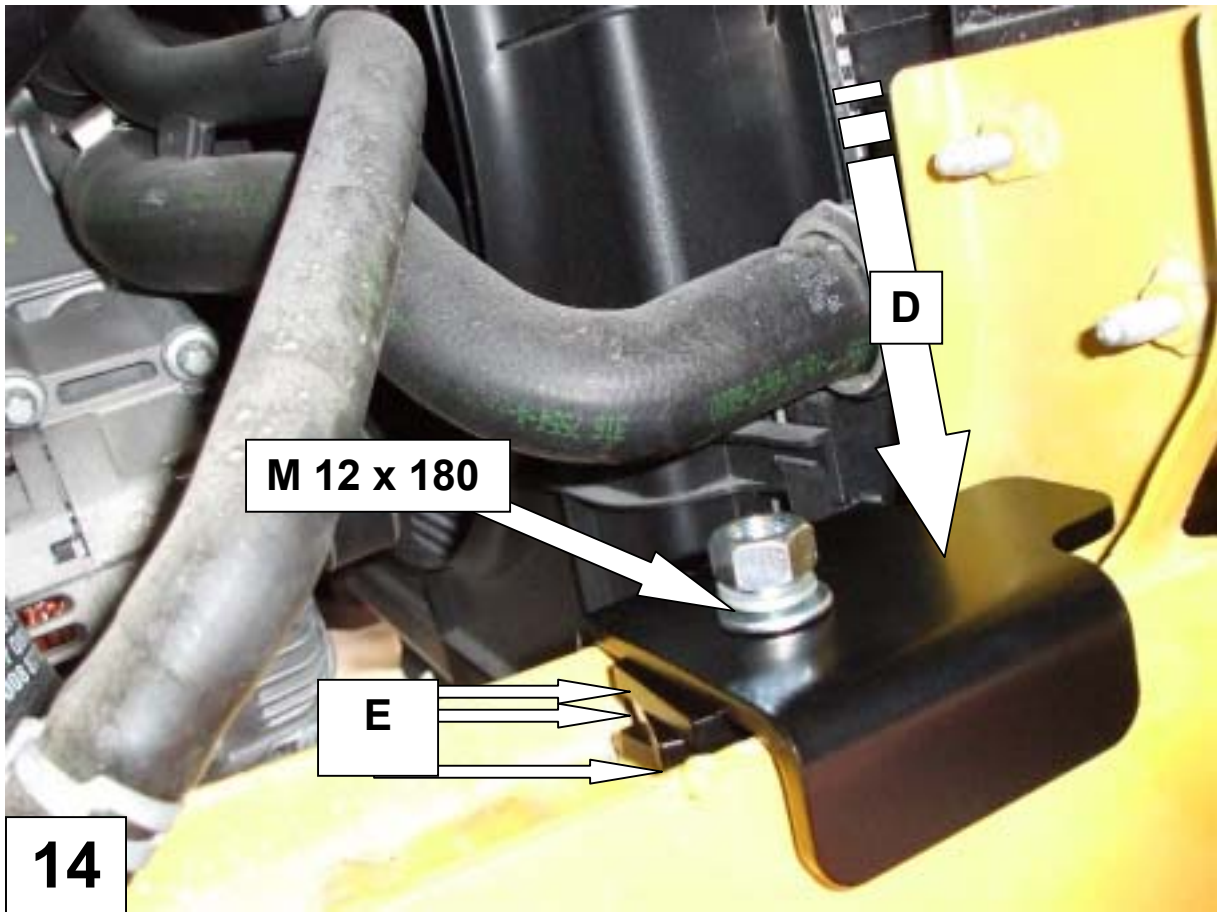
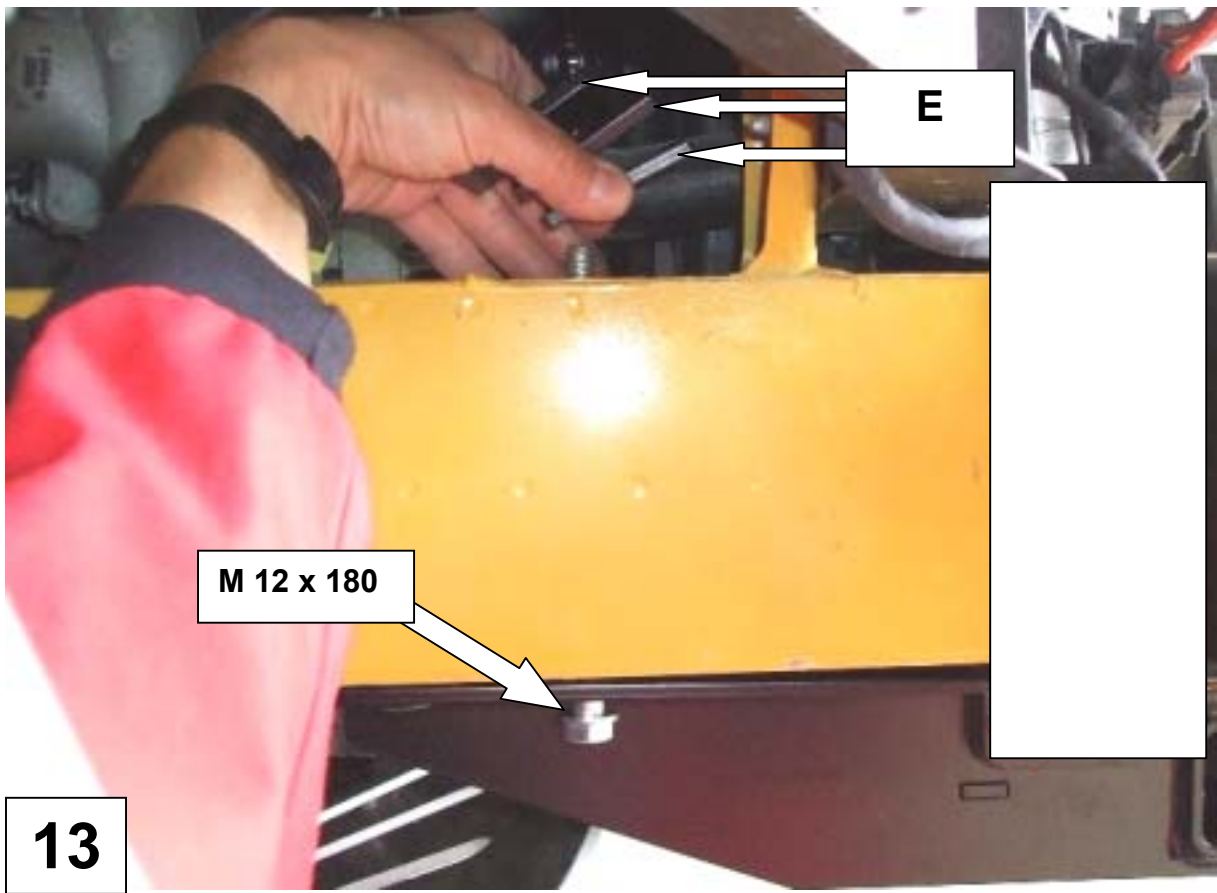

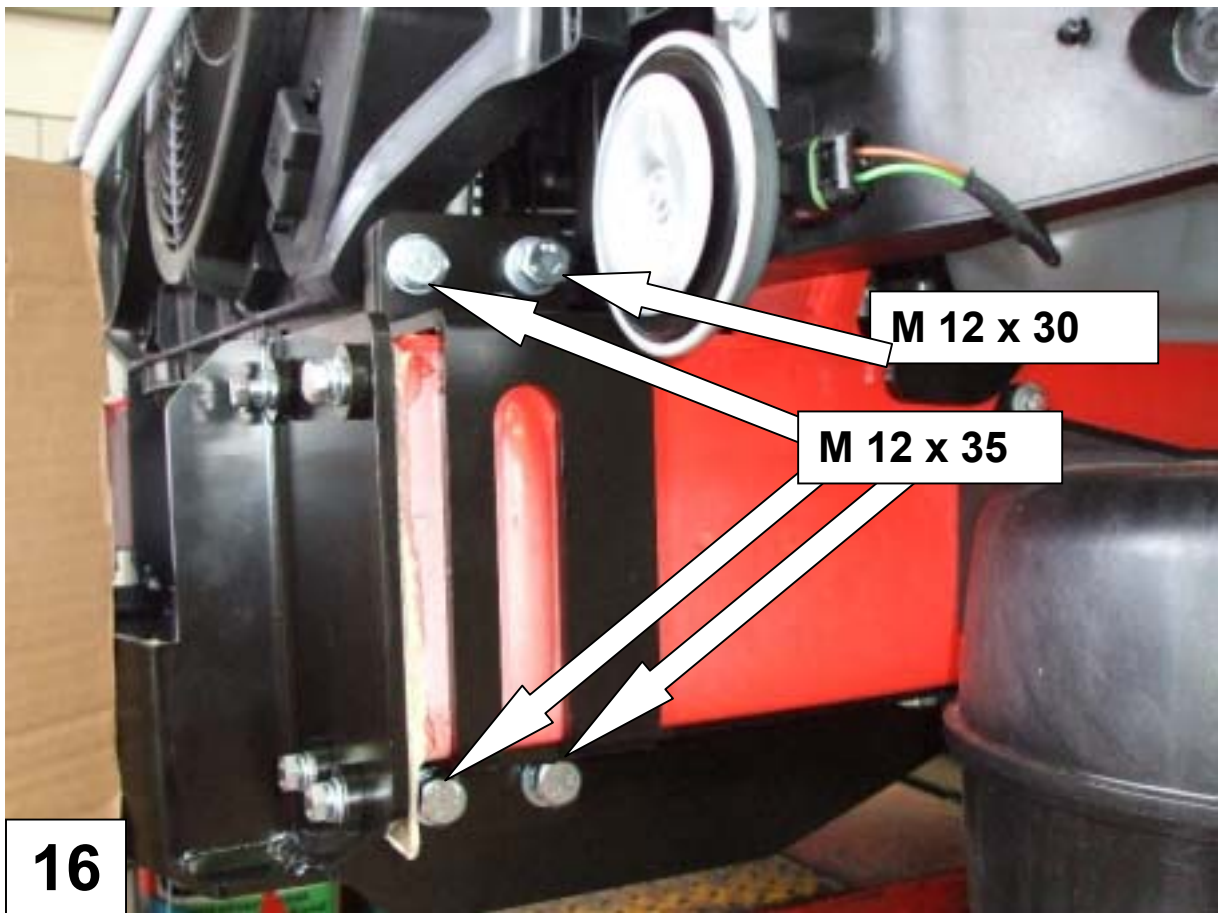
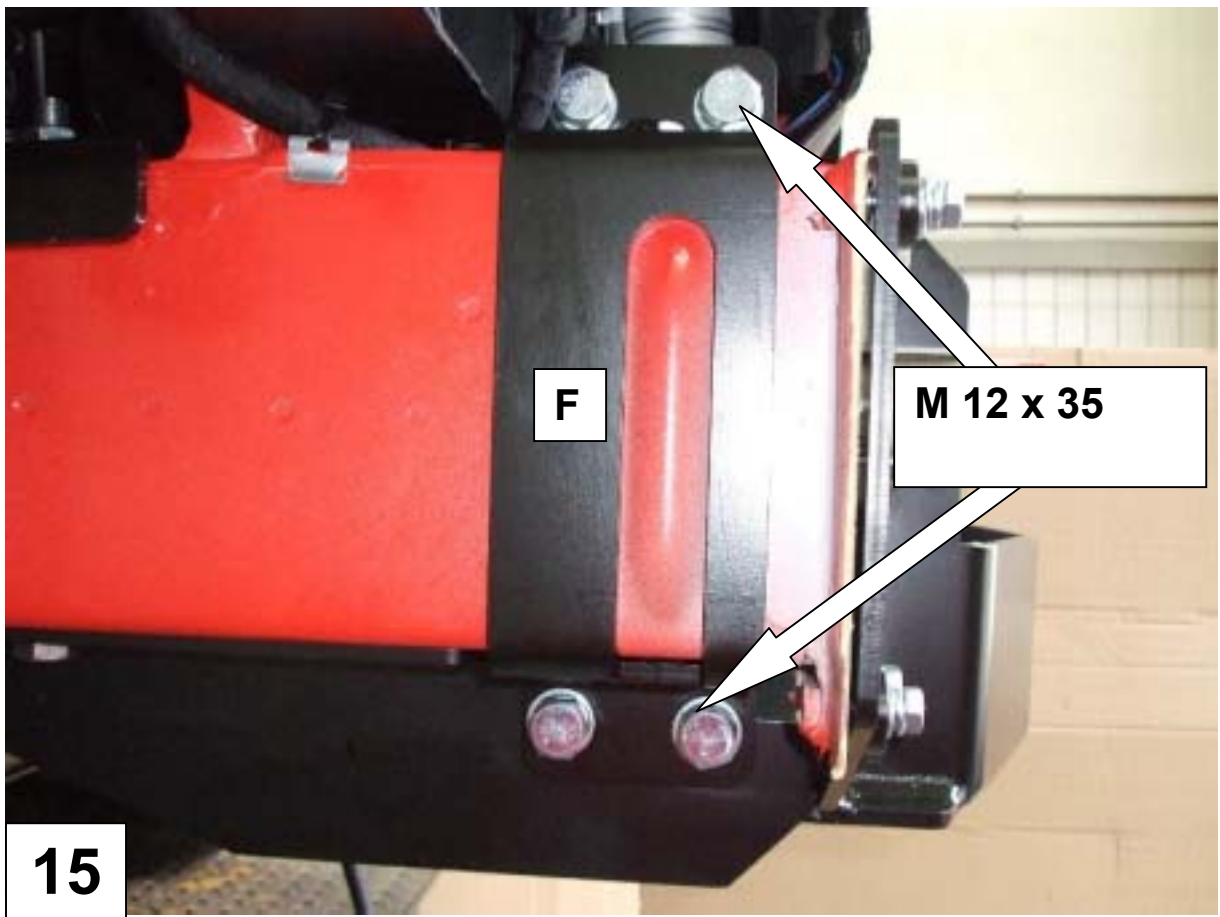

Ziehen sie die Schrauben in folgender Reihenfolge fest .

Tighten the screws in the following raw.

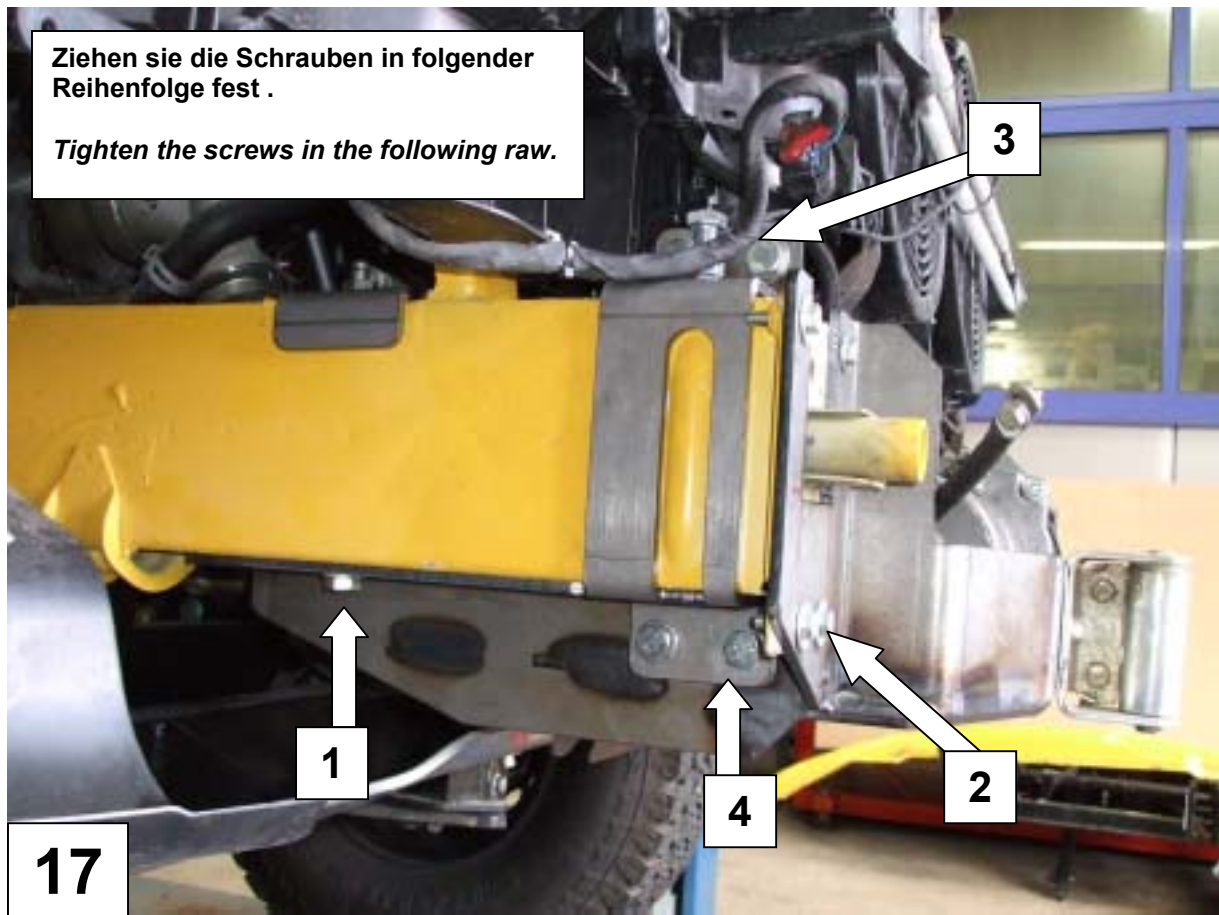



19

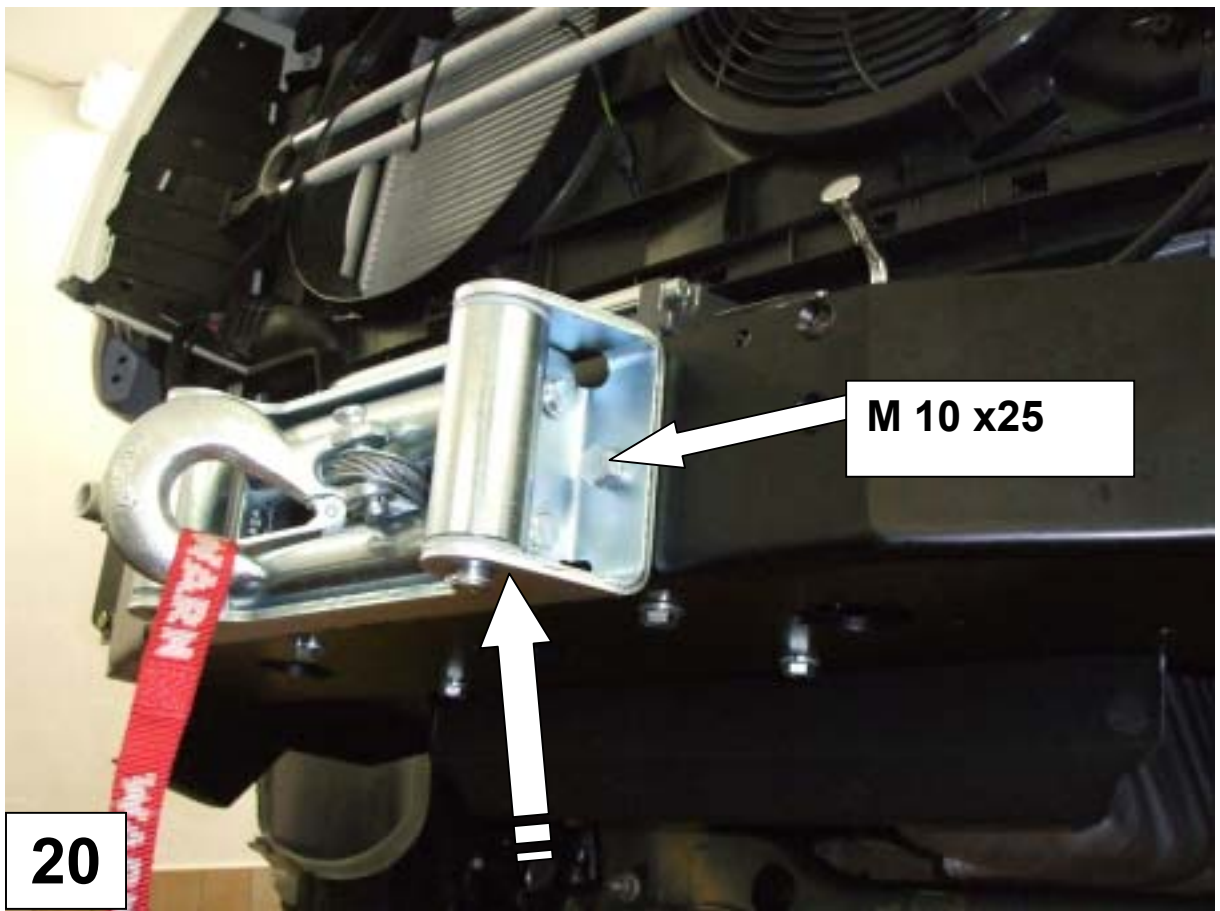

20

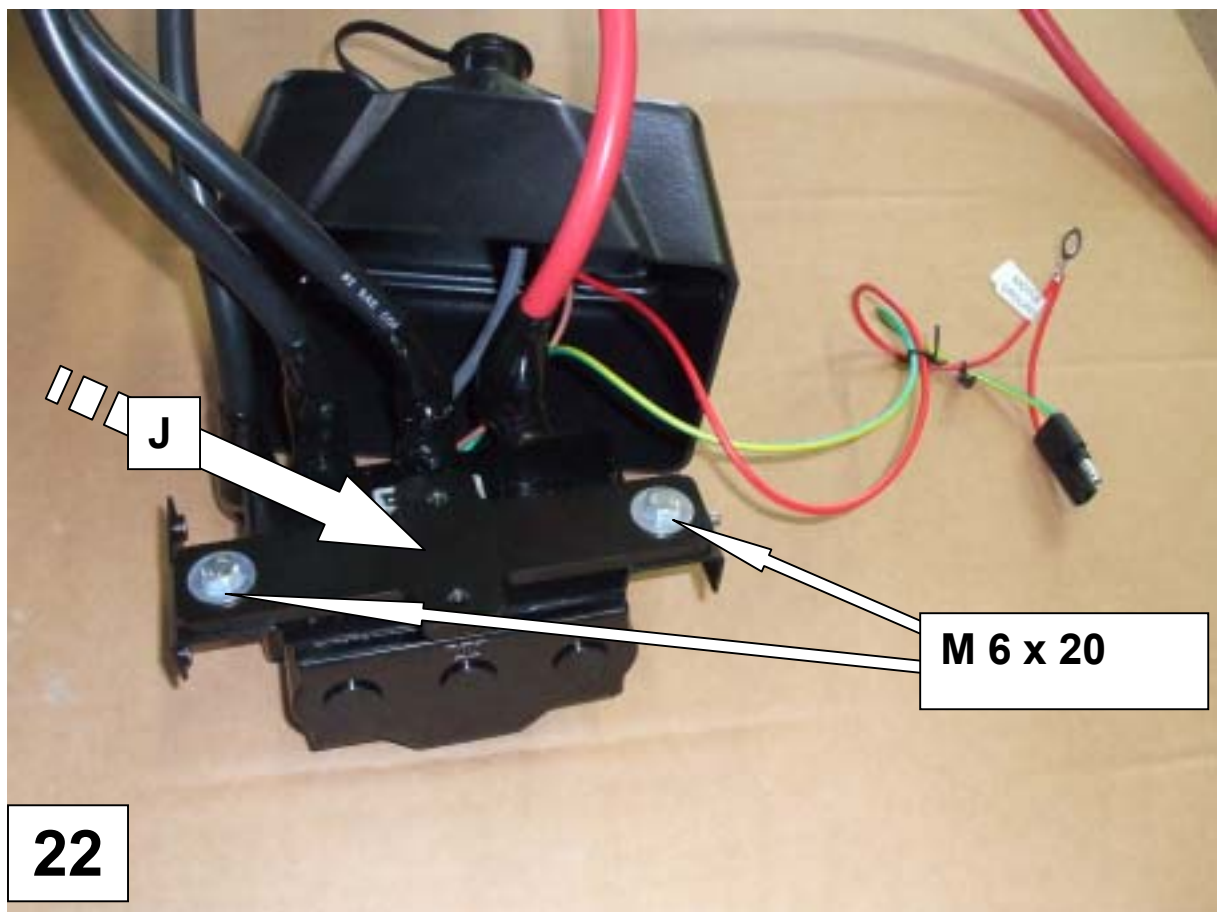
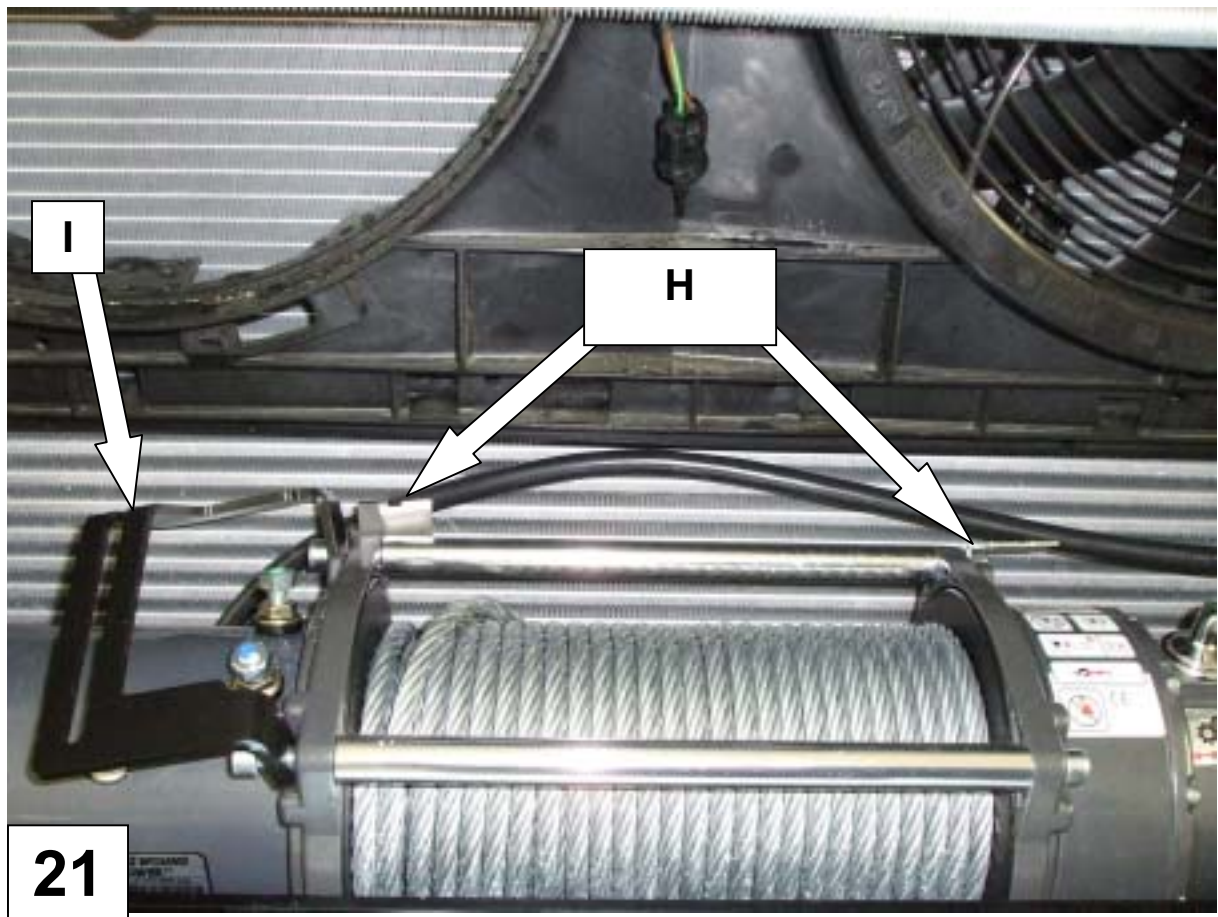

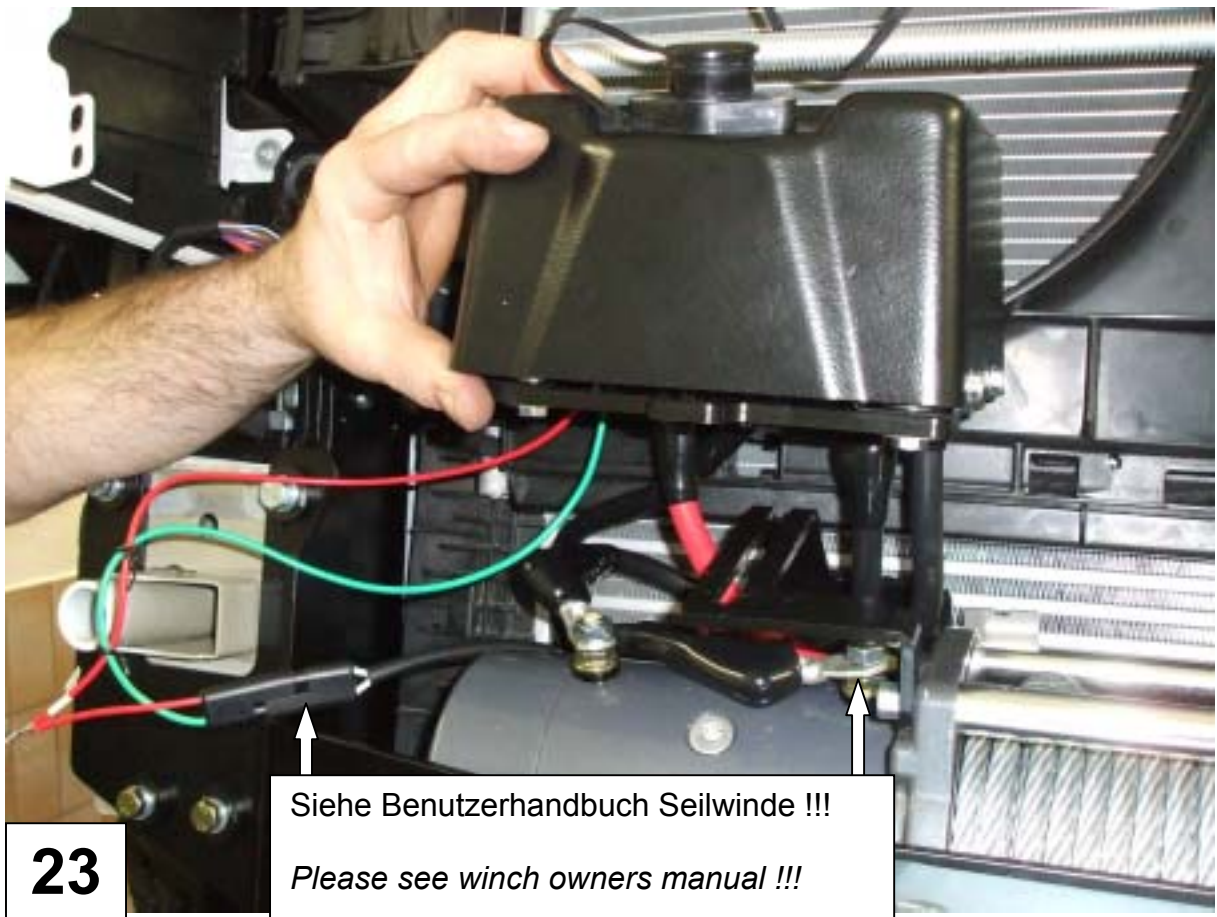

23

Siehe Benutzerhandbuch Seilwinde !!!
Please see winch owners manual !!!

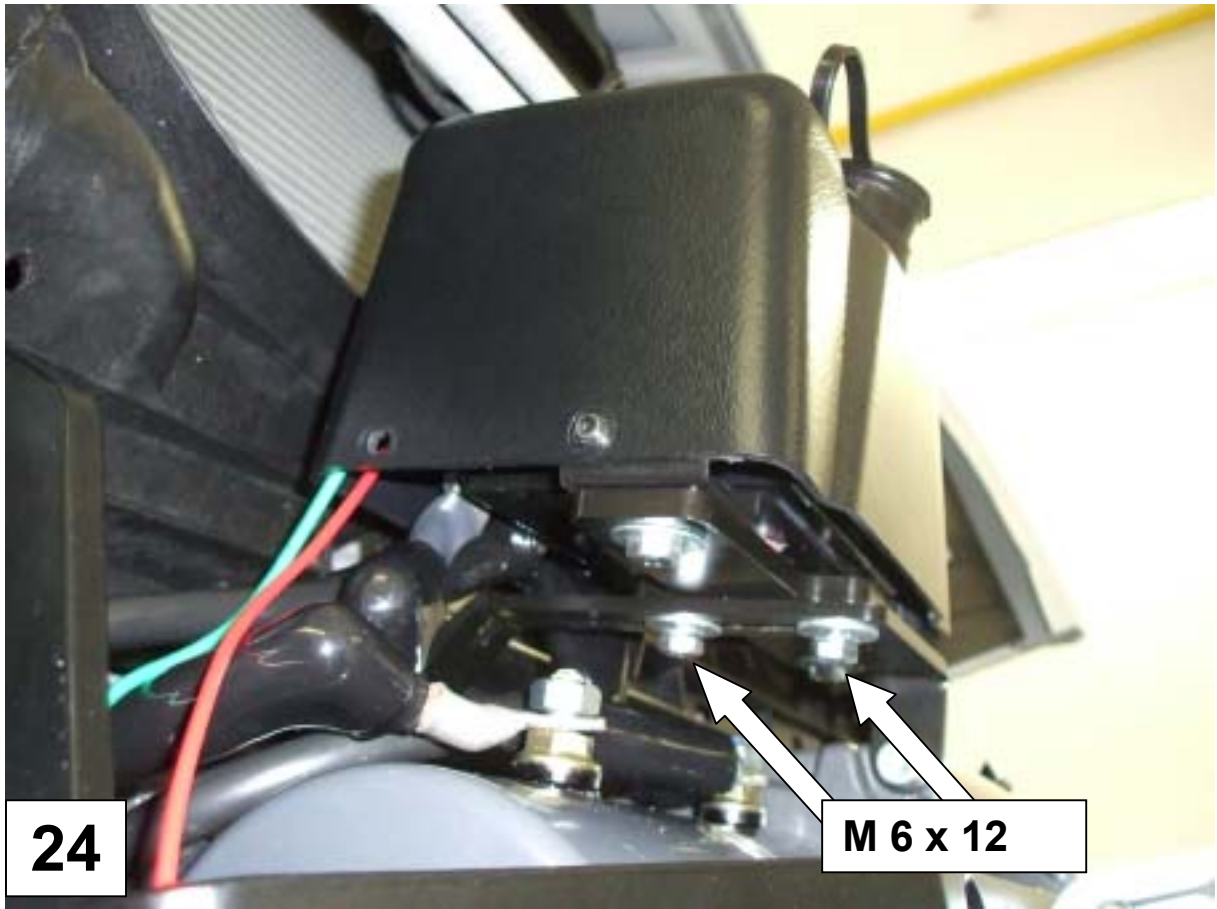

24

M 6 x 12

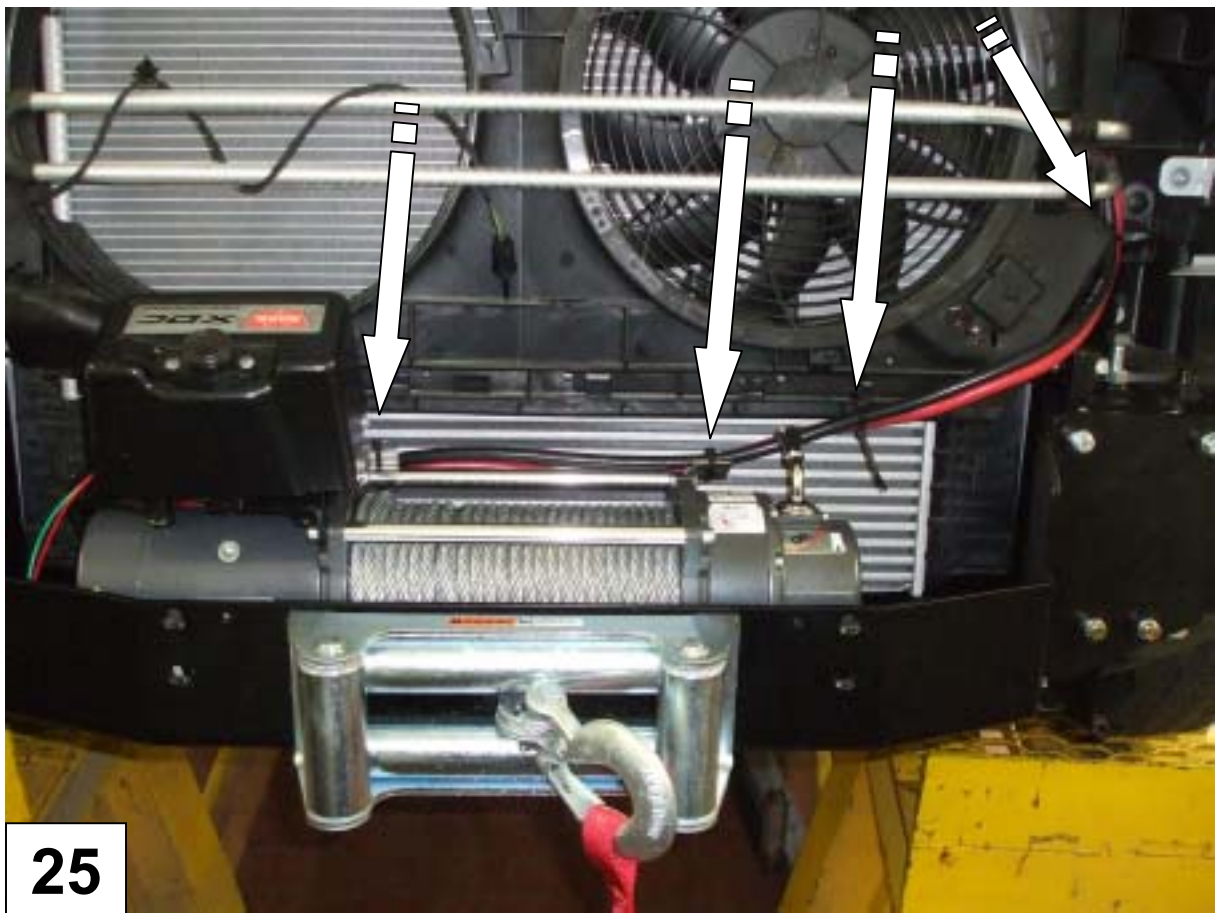

25

**Achtung Schritte 26 bis 29 sind nur für Mercedes Sprinter!!
Attention stepp 26 to 29 for Mercedes Sprinter only !!!**



26

**Ausschneiden !!!
Cut out !!!**





29

Achtung Schritte 30 bis 32 sind nur für VW Crafter!!
Attention Stepp 30 to 32 for VW Crafter only!!

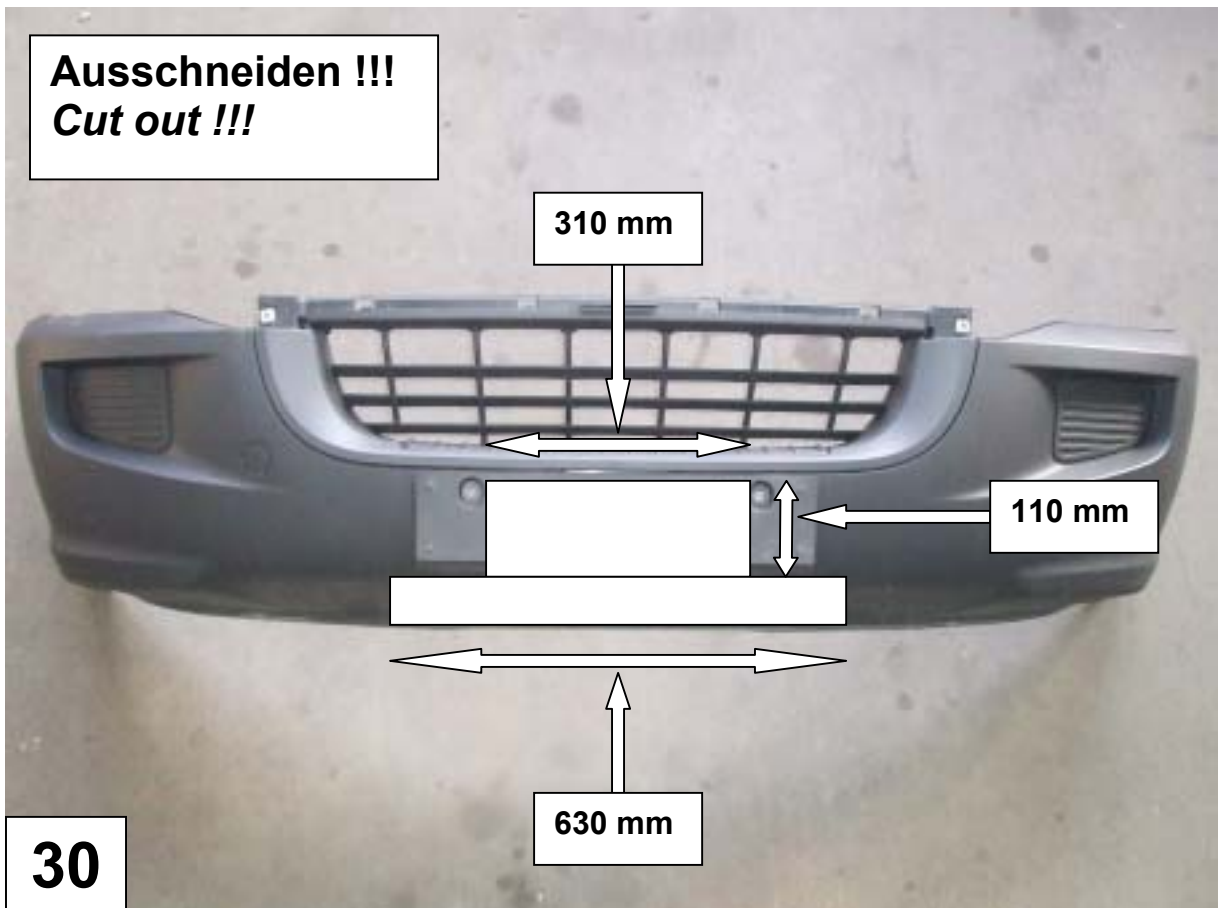

30

Ausschneiden !!!
Cut out !!!



31



32